

CASEGOODS

PARSONS, OCCASIONAL TABLES &
VISUAL PRESENTATION



SPECIFICATION GUIDE

REV 111924

NOTE: Due to the recent unanticipated cost increase of raw materials please call to confirm list pricing before you quote your clients

COLECRAFT
The Art of Detail™

CASEGOODS

Storage and Wall Furniture

Typicals _____ 3
 29" high _____ 5
 36" high _____ 6 - 7
 45" hutches _____ 8
 Mobile storage _____ 9

Compose Credenzas

Buffet Height 36" _____ 12
 Footed Buffet Height 36" _____ 14
 Conference Height 29" _____ 16
 Footed Conference Height 29" _____ 18
 Low 24" and Wall Hung 18" Height _____ 20

Public Spaces

Classic parsons tables _____ 22
 Panel parsons tables _____ 24
 Waterfall tables _____ 26
 Height Adjustable Parsons _____ 28
 Standing Height Teachers Lectern _____ 29
 Cube tables _____ 30
 Drum tables _____ 31
 Pedestals _____ 32
 Display Cases _____ 33
 Lecterns _____ 34 - 35
 Adjustable Height Lecterns _____ 36
 Lockers _____ 37

Visual Presentation

Tackboards _____ 38
 Whiteboards _____ 40
 Presentation cabinets _____ 42

Dining Typicals



Typical WFN-211
 36" Wide Wall
 36"W Base with Drawers
 36"W Partial Dr Hutch - Solid Doors

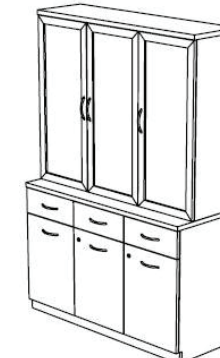

Typical WFN-212
 54" Wide Wall
 54"W Base with Drawers
 18"W Full Dr Hutch - Glass Drs
 36"W Full Dr Hutch - Glass Drs



Typical WFN-213
 72" Wide Wall
 72"W Base with Drawers
 72"W Partial Dr Hutch - Glass Drs



Typical WFN-214
 90" Wide Wall
 54"W Base with Drawers
 2 - 18"W One Dr Base (36"H)
 54"W Partial Dr Hutch - Glass Drs
 2 - 18"W Full Dr Hutches - Glass Drs

Conference Room Typicals



Typical WFN-215
 72" Wide Wall
 36"W Lateral File Base
 2 - 18"W One Dr Base (30"H)
 2 - 18"W Full Dr Hutches - Solid Drs
 36"W Partial Dr Hutch - Solid Drs

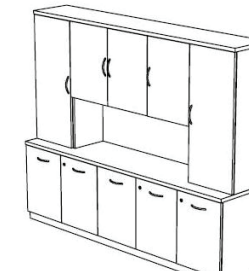

Typical WFN-216
 90" Wide Wall
 90"W 5 Dr Base (30" or 36" H)
 54"W Partial Dr Hutch - Solid Drs
 2 - 18"W Full Dr Hutches - Solid Drs



Typical WFN-217
 108" Wide Wall
 2 - 36"W Lateral File Bases
 2 - 18"W One Dr Bases (30"H)



Typical WFN-218
 180" Wide Wall
 2 - 36"W Lateral File Bases
 2 - 36"W Open Bases (30"H)
 2 - 18"W One Dr Bases (30"H)
 2 - 18"W Full Dr Hutches - Solid Drs
 2 - 36"W Full Dr Hutches - No Drs
 2 - 36"W Full Dr Hutches - Solid Drs

Audio Visual Wall Typicals



Typical WFN-219
 36" Cabinet for Video
 36"W Base with Drawers
 (30" or 36"H)



Typical WFN-220
 72" Wall w/ 36" Video
 72"W 4 Dr Base (30" or 36"H)
 36"W Video Panel Hutch for 32"
 2 - 18"W Full Dr Hutches - No Drs



Typical WFN-221
 126" Wall w/ 54" Video
 2 - 36"W Open Bases (30" or 36"H)
 54"W 3 Dr Base (30" or 36"H)
 54"W Video Panel Hutch for 42"
 2 - 36"W Full Dr Hutches - No Drs

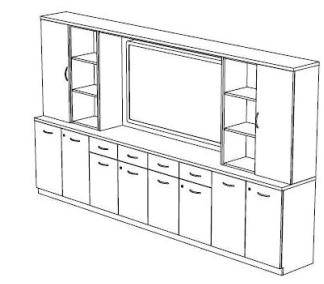

Typical WFN-222
 144" Wall w/ 72" Video
 72"W Four Dr Base with Drawers
 2 - 36"W Two Dr Bases (36"H)
 72"W Video Panel Hutch for 52"
 2 - 18"W Full Dr Hutches - No Drs
 2 - 18"W Full Dr Hutches - Solid Drs

Credenza - 29" Table Height

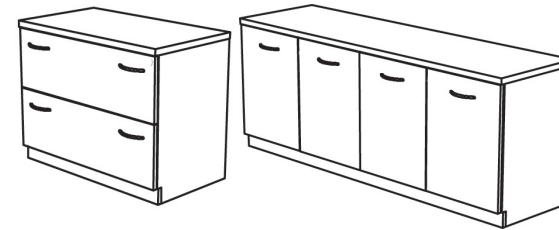

- Features:
- Adjustable shelves
 - European hinges
 - Adjustable floor glides
 - Add locks \$125 Per drawer/bay
 - Multiple hardware options
 - Option to use individual tops or one continuous top on all bases

- WKNF1
- WBNS1
- WDRD1
- WRBV1
- WBEV1
- WTRD1



WOOD EDGE

- WBNS
- WDRD
- WRBV
- WBEV
- WTRD

- WXWE*
- WXCR
- WXBV
- WXBD
- WXRD
- WXFL
- WXBVL*

LAMINATE/PVC

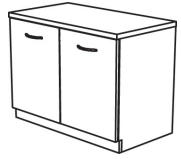
- SE*
- PVC
- LBVL*

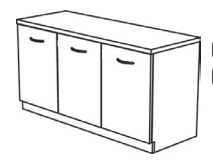
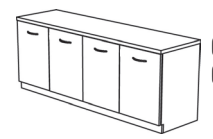
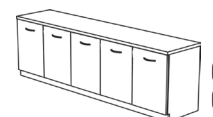
	MODEL #	DIMENSIONS	MATERIAL	DELUXE	PREMIUM	STANDARD	BASIC	
ONE DOOR		CR D1 VN 182029	18" w x 20" d x 29" h	WOOD	\$3,789	\$3,525	\$3,259	N/A
		CR D1 LM 182029	18" w x 20" d x 29" h	LAMINATE	\$3,150	\$2,976	\$2,803	\$2,629
TWO DOOR		CR D2 VN 362029	36" w x 20" d x 29" h	WOOD	\$5,873	\$5,464	\$5,052	N/A
		CR D2 LM 362029	36" w x 20" d x 29" h	LAMINATE	\$4,988	\$4,654	\$4,319	\$4,076
LATERAL FILE		CR LAT VN 362029	36" w x 20" d x 29" h	WOOD	\$6,461	\$6,009	\$5,556	N/A
		CR LAT LM 362029	36" w x 20" d x 29" h	LAMINATE	\$5,396	\$5,061	\$4,725	\$4,483
OPEN BASE		CR BK2 VN 362029	36" w x 20" d x 29" h	WOOD	\$5,287	\$4,950	\$4,547	N/A
		CR BK2 LM 362029	36" w x 20" d x 29" h	LAMINATE	\$4,580	\$4,276	\$3,911	\$3,668
THREE DOOR		CR D3 VN 542029	54" w x 20" d x 29" h	WOOD	\$6,991	\$6,503	\$6,012	N/A
		CR D3 LM 542029	54" w x 20" d x 29" h	LAMINATE	\$6,095	\$5,649	\$5,203	\$4,851
FOUR DOOR		CR D4 VN 722029	72" w x 20" d x 29" h	WOOD	\$8,179	\$7,584	\$7,034	N/A
		CR D4 LM 722029	72" w x 20" d x 29" h	LAMINATE	\$6,666	\$6,380	\$6,093	\$5,675
FIVE DOOR		CR D5 VN 902029	90" w x 20" d x 29" h	WOOD	\$9,570	\$8,901	\$8,230	N/A
		CR D5 LM 902029	90" w x 20" d x 29" h	LAMINATE	\$8,387	\$7,774	\$7,160	\$6,640

Notes : WOOD EDGE PROFILE ON FRONT OF TOP ONLY. ADD 10% FOR WOOD EDGE PROFILE ON THREE SIDES. Our Deluxe and Standard edges are available 1-3/4" thickness add 10 % • Edges WXBVL, LBVL add 5% • SE Add 10% • Edge WXWE subtract 10% • Optional Lock Add \$125 per Drawer Bay Color options Black, Silver, White • Optional Finished Back add 15% • Dura-Coat Available at the same price as Veneer

Casegoods Storage & Wall Furniture

COLECRAFT

Credenza - 36" Buffet Height

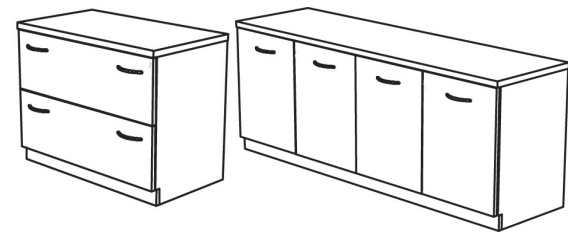

- Features:
- Adjustable shelves
 - European hinges
 - Adjustable floor glides
 - Add locks \$125 Per drawer/bay
 - Multiple hardware options
 - Option to use individual tops or one continuous top on all bases

WKNF1	WBNS	WXWE*	SE*
WBNS1	WDRD	WXCR	PVC
WDRD1	WRBV	WXBV	
WRBV1	WBEV	WXBD	
WBEV1	WTRD	WXRD	
WTRD1		WXFL	
		WXBVL*	LBVL*

	MODEL #	DIMENSIONS	MATERIAL	DELUXE	PREMIUM	STANDARD	BASIC
ONE DOOR	CR D1 VN 182036	18"w x 20"d x 36"h	WOOD	\$4,976	\$4,436	\$4,073	N/A
	CR D1 LM 182036	18"w x 20"d x 36"h	LAMINATE	\$3,622	\$3,424	\$3,224	\$3,024
TWO DOOR	CR D2 VN 362036	36"w x 20"d x 36"h	WOOD	\$7,343	\$6,830	\$6,314	N/A
	CR D2 LM 362036	36"w x 20"d x 36"h	LAMINATE	\$5,736	\$5,351	\$4,967	\$4,687
OPEN BASE	CR BK2 VN 362036	36"w x 20"d x 36"h	WOOD	\$6,610	\$6,147	\$5,683	N/A
	CR BK2 LM 362036	36"w x 20"d x 36"h	LAMINATE	\$5,269	\$4,719	\$4,499	\$4,220
THREE DOOR	CR D3 VN 542036	54"w x 20"d x 36"h	WOOD	\$8,739	\$8,128	\$7,515	N/A
	CR D3 LM 542036	54"w x 20"d x 36"h	LAMINATE	\$7,008	\$6,496	\$5,984	\$5,579
FOUR DOOR	CR D4 VN 722036	72"w x 20"d x 36"h	WOOD	\$10,224	\$9,509	\$8,793	N/A
	CR D4 LM 722036	72"w x 20"d x 36"h	LAMINATE	\$7,667	\$7,338	\$7,008	\$6,526
FIVE DOOR	CR D5 VN 902036	90"w x 20"d x 36"h	WOOD	\$11,963	\$11,126	\$10,288	N/A
	CR D5 LM 902036	90"w x 20"d x 36"h	LAMINATE	\$9,644	\$8,959	\$8,273	\$7,636

Notes : WOOD EDGE PROFILE ON FRONT OF TOP ONLY. ADD 10% FOR WOOD EDGE PROFILE ON THREE SIDES. Our Deluxe and Standard edges are available 1-3/4" thickness add 10% • Edges WXBVL, LBVL add 5% • SE Add 10% • Edge WXWE subtract 10% • Optional Lock Add \$125 per Drawer Bay Color options Black, Silver, White • Optional Finished Back add 15% • Dura-Coat Available at the same price as Veneer

Casegoods Storage & Wall Furniture

COLECRAFT

Credenza with Drawers - 36" Buffet Height

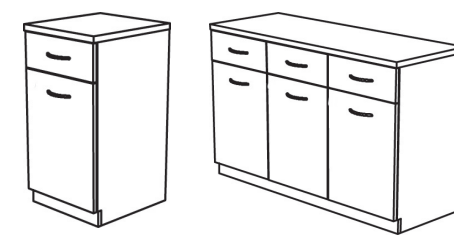

- Features:
- Adjustable shelves
 - European hinges
 - Locking casters
 - Optional flip up shelves can be added
 - Add locks \$125 Per drawer/bay
 - Optional gallery rail can be added
 - Hardware options are in our Finishes and Hardware Guide

WKNF1	WBNS	WXWE*	SE*
WBNS1	WDRD	WXCR	PVC
WDRD1	WRBV	WXBV	
WRBV1	WBEV	WXBD	
WBEV1	WTRD	WXRD	
WTRD1		WXFL	
		WXBVL*	LBVL*

	MODEL #	DIMENSIONS	MATERIAL	DELUXE	PREMIUM	STANDARD	BASIC
ONE DRAWER/DOOR	CR DD1 VN 182036	18"w x 20"d x 36"h	WOOD	\$5,095	\$4,831	\$4,567	N/A
	CR DD1 LM 182036	18"w x 20"d x 36"h	LAMINATE	\$3,690	\$3,516	\$3,343	\$3,170
TWO DRAWER/DOOR	CR DD2 VN 362036	36"w x 20"d x 36"h	WOOD	\$7,900	\$7,489	\$7,077	N/A
	CR DD2 LM 362036	36"w x 20"d x 36"h	LAMINATE	\$5,825	\$5,492	\$5,156	\$4,914
OPEN SHELF	CR BK3 VN 362036	36"w x 20"d x 36"h	WOOD	\$7,109	\$6,740	\$6,370	N/A
	CR BK3 LM 362036	36"w x 20"d x 36"h	LAMINATE	\$5,242	\$4,826	\$4,641	\$4,423
THREE DRAWER/DOOR	CR DD3 VN 542036	54"w x 20"d x 36"h	WOOD	\$9,400	\$8,911	\$8,422	N/A
	CR DD3 LM 542036	54"w x 20"d x 36"h	LAMINATE	\$7,091	\$6,646	\$6,200	\$5,849
FOUR DRAWER/DOOR	CR DD4 VN 722036	72"w x 20"d x 36"h	WOOD	\$11,003	\$10,432	\$9,859	N/A
	CR DD4 LM 722036	72"w x 20"d x 36"h	LAMINATE	\$7,834	\$7,546	\$7,259	\$6,841
FIVE DRAWER/DOOR	CR DD5 VN 902036	90"w x 20"d x 36"h	WOOD	\$12,875	\$12,206	\$11,535	N/A
	CR DD5 LM 902036	90"w x 20"d x 36"h	LAMINATE	\$9,751	\$9,155	\$8,559	\$8,006

Notes : WOOD EDGE PROFILE ON FRONT OF TOP ONLY. ADD 10% FOR WOOD EDGE PROFILE ON THREE SIDES. Our Deluxe and Standard edges are available 1-3/4" thickness add 10% • Edges WXBVL, LBVL add 5% • SE Add 10% • Edge WXWE subtract 10% • Optional Lock Add \$125 per Drawer Bay Color options Black, Silver, White • Optional Finished Back add 15% • Dura-Coat Available at the same price as Veneer

Casegoods Storage & Wall Furniture

Credenza Hutch- 45" Height

The credenza hutches can be used in combination with any of our credenzas. They are available with and without doors in a variety of sizes and styles in the veneer or laminate of your choice. We also offer a video panel hutch unit to accommodate 32", 42" or 52" flat panel monitors, this unit includes the video mount. The possibilities are endless in creating the perfect wall storage configuration for your office, conference room, training room, lobby or dining area.

WOOD EDGE		LAMINATE/PVC	
WKNF1	WBNS	WXWE*	SE*
WBNS1	WDRD	WXCR	PVC
WDRD1	WRBV	WXBV	
WRBV1	WBEV	WXBD	
WBEV1	WTRD	WXRD	
WTRD1		WXFL	
		WXBVL*	LBVL*

MODEL #	DIMENSIONS	MATERIAL	DELUXE	PREMIUM	STANDARD	BASIC
OPEN HUTCH - SOLID DOOR - GLASS FRAMED DOOR						
HU ND VN 181545	18"w x 15"d x 45"h	WOOD	\$2,879	\$2,811	\$2,742	N/A
HU ND LM 181545	18"w x 15"d x 45"h	LAMINATE	\$2,159	\$2,108	\$2,056	\$1,780
HU FSD VN 181545	18"w x 15"d x 45"h	WOOD	\$3,282	\$3,204	\$3,125	N/A
HU FSD LM 181545	18"w x 15"d x 45"h	LAMINATE	\$2,463	\$2,420	\$2,345	\$2,030
HU FGD VN 181545	18"w x 15"d x 45"h	WOOD	\$3,850	\$3,759	\$3,667	N/A
HU FGD LM 181545	18"w x 15"d x 45"h	LAMINATE	N/A	N/A	N/A	N/A
OPEN HUTCH - SOLID DOOR - GLASS FRAMED DOOR						
HU ND VN 361545	36"w x 15"d x 45"h	WOOD	\$4,431	\$4,326	\$4,220	N/A
HU ND LM 361545	36"w x 15"d x 45"h	LAMINATE	\$3,323	\$3,244	\$3,165	\$2,373
HU FSD VN 361545	36"w x 15"d x 45"h	WOOD	\$5,051	\$4,930	\$4,810	N/A
HU FSD LM 361545	36"w x 15"d x 45"h	LAMINATE	\$3,787	\$3,698	\$3,607	\$2,705
HU FGD VN 361545	36"w x 15"d x 45"h	WOOD	\$5,924	\$5,784	\$5,642	N/A
HU FGD LM 361545	36"w x 15"d x 45"h	LAMINATE	N/A	N/A	N/A	N/A
SOLID DOOR - GLASS FRAMED DOOR						
HU CSD VN 361545	36"w x 15"d x 45"h	WOOD	\$4,426	\$4,321	\$4,215	N/A
HU CSD LM 361545	36"w x 15"d x 45"h	LAMINATE	\$3,320	\$3,241	\$3,161	\$2,370
HU CGFD VN 361545	36"w x 15"d x 45"h	WOOD	\$4,930	\$4,813	\$4,694	N/A
HU CGFD LM 361545	36"w x 15"d x 45"h	LAMINATE	N/A	N/A	N/A	N/A
SOLID DOOR - GLASS FRAMED DOOR						
HU CSD VN 541545	54"w x 15"d x 45"h	WOOD	\$6,237	\$6,088	\$5,939	N/A
HU CSD LM 541545	54"w x 15"d x 45"h	LAMINATE	\$4,677	\$4,565	\$4,453	\$3,340
HU CGFD VN 541545	54"w x 15"d x 45"h	WOOD	\$6,947	\$6,782	\$6,617	N/A
HU CGFD LM 541545	54"w x 15"d x 45"h	LAMINATE	N/A	N/A	N/A	N/A
SOLID DOOR - GLASS FRAMED DOOR						
HU CSD VN 721545	72"w x 15"d x 45"h	WOOD	\$8,047	\$7,855	\$7,664	N/A
HU CSD LM 721545	72"w x 15"d x 45"h	LAMINATE	\$6,035	\$5,891	\$5,748	\$4,311
HU CGFD VN 721545	72"w x 15"d x 45"h	WOOD	\$8,964	\$8,736	\$8,537	N/A
HU CGFD LM 721545	72"w x 15"d x 45"h	LAMINATE	N/A	N/A	N/A	N/A
HUTCH FRO 32", 42", 52" TV						
HU VD VN 361545	36"w x 15"d x 45"h	WOOD	\$6,126	\$6,042	\$5,958	N/A
HU VD LM 361545	36"w x 15"d x 45"h	LAMINATE	\$5,244	\$5,241	\$5,118	\$4,488
HU VD VN 541545	54"w x 15"d x 45"h	WOOD	\$7,654	\$7,533	\$7,413	N/A
HU VD LM 541545	54"w x 15"d x 45"h	LAMINATE	\$6,390	\$6,301	\$6,210	\$5,307
HU VD VN 721545	72"w x 15"d x 45"h	WOOD	\$9,182	\$9,025	\$8,868	N/A
HU VD LM 721545	72"w x 15"d x 45"h	LAMINATE	\$7,535	\$7,419	\$7,302	\$6,126

Notes : WOOD EDGE PROFILE ON FRONT OF TOP ONLY. ADD 10% FOR WOOD EDGE PROFILE ON THREE SIDES. Our Deluxe and Standard edges are available 1-3/4" thickness add 10% • Edges WXBVL, LBVL add 5% • SE Add 10% • Edge WXWE subtract 10% • Optional Lock Add \$125 per Drawer Bay Color options Black, Silver, White • Optional Finished Back add 15% • Dura-Coat Available at the same price as Veneer

Casegoods Storage & Wall Furniture

Mobile Storage And Service Carts

WOOD EDGE		LAMINATE/PVC	
WKNF1	WBNS	WXWE*	SE*
WBNS1	WDRD	WXCR	PVC
WDRD1	WRBV	WXBV	
WRBV1	WBEV	WXBD	
WBEV1	WTRD	WXRD	
WTRD1		WXFL	
		WXBVL*	LBVL*

MODEL #	DIMENSIONS	MATERIAL	DELUXE	PREMIUM	STANDARD	BASIC
TWO DOOR MOBILE STORAGE						
MBS D2 VN 362636	36"w x 26"d x 36"h	WOOD	\$7,091	\$7,003	\$6,488	N/A
MBS D2 LM 362636	36"w x 26"d x 36"h	LAMINATE	\$5,575	\$5,525	\$5,140	\$4,861
2 DRAWER/DOOR MOBILE STORAGE						
MBS DD2 VN 362636	36"w x 26"d x 36"h	WOOD	\$7,616	\$7,662	\$7,251	N/A
MBS DD2 LM 362636	36"w x 26"d x 36"h	LAMINATE	\$5,659	\$5,665	\$5,330	\$5,087
FLIP UP SHELVES						
MBS FUS VN 1226	12"w x 26"d	WOOD	\$1,337	\$1,252	\$1,087	\$868
MBS FUS LM 1226	12"w x 26"d	LAMINATE	N/A	N/A	N/A	N/A
GALLERY RAIL						
MBS GR VN 363	36"w x 3"h	WOOD	\$1,053	\$1,117	\$1,117	\$1,117
MBS GR LM 363	36"w x 3"h	LAMINATE	N/A	N/A	N/A	N/A

Notes : WOOD EDGE PROFILE ON FRONT OF TOP ONLY. ADD 10% FOR WOOD EDGE PROFILE ON THREE SIDES. Our Deluxe and Standard edges are available 1-3/4" thickness add 10% • Edges WXBVL, LBVL add 5% • SE Add 10% • Edge WXWE subtract 10% • Optional Lock Add \$125 per Drawer Bay Color options Black, Silver, White • Optional Finished Back add 15% • Dura-Coat Available at the same price as Veneer

Casegoods *Compose* Credenzas

COLECRAFT

Colecraft Compose Credenzas are completely Customizable To suit your specific needs. Choose the size that best fits your Area. Next Compose your Credenza with the components that suit your needs.

First choose the size of the credenza that suits you
Second Customize it to suit your specific needs with the components on the adjacent page.

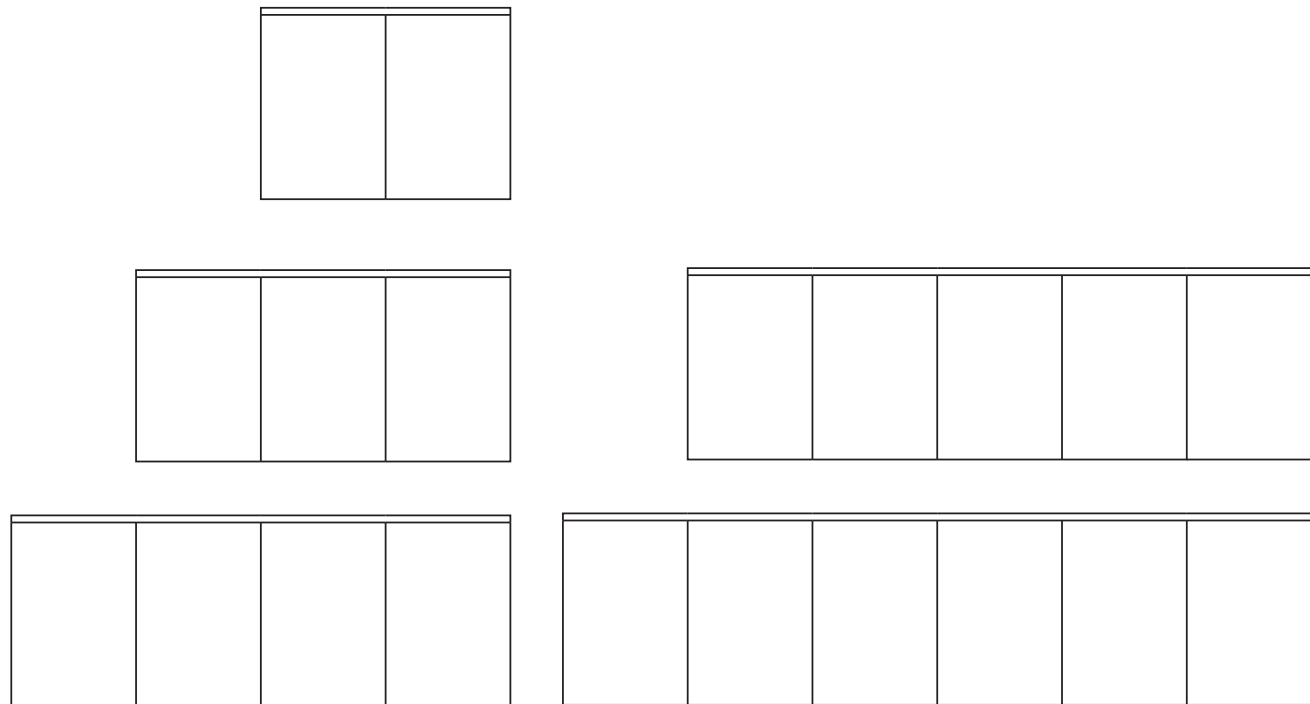

Casegoods *Compose* Credenzas

COLECRAFT

Compose Options

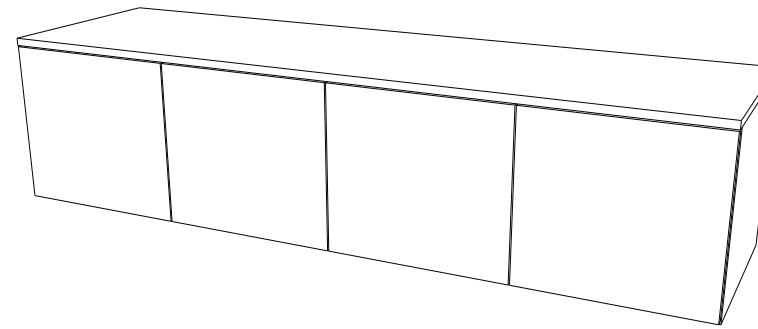

WALL HUNG OPTION

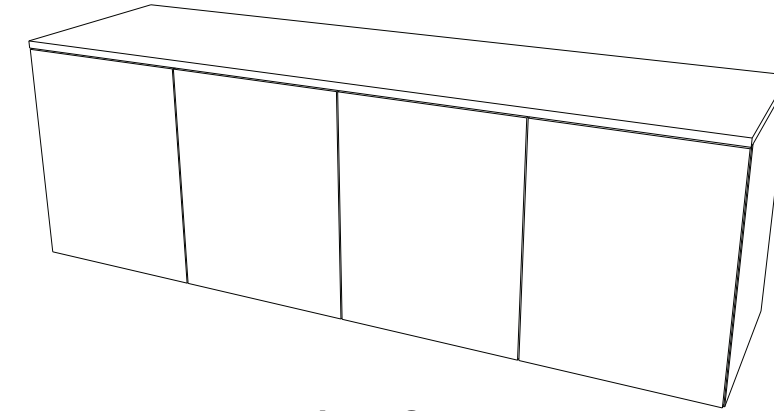

LOW OPTION

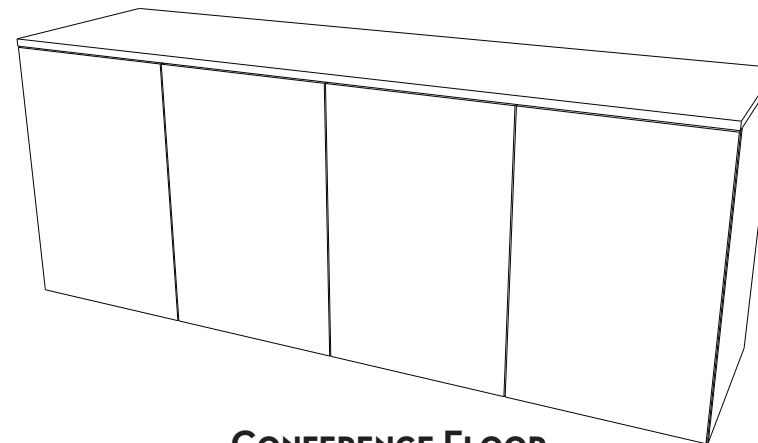

CONFERENCE FLOOR

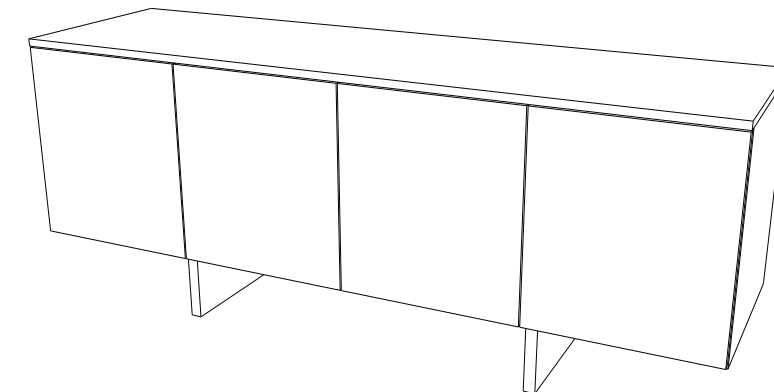

CONFERENCE LEGGED

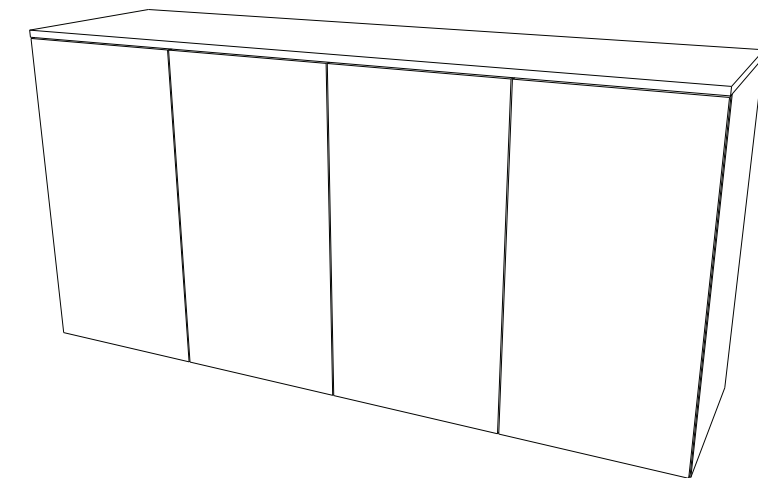

BUFFET FLOOR

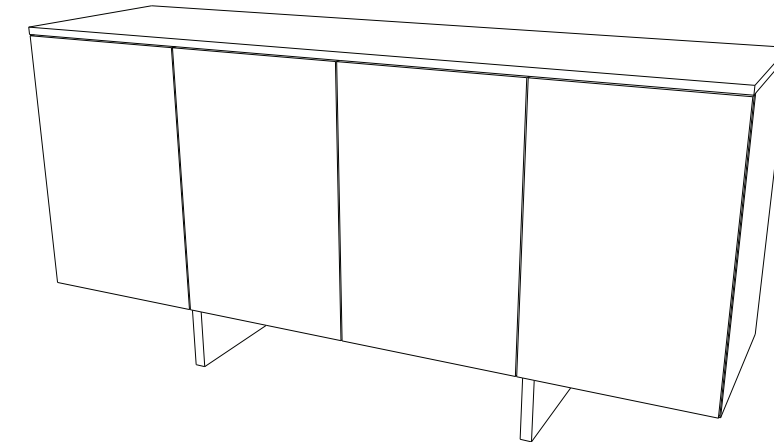

BUFFET LEGGED

General Information:

- Tops are 3/4"-thick. Specialty Tops add an Additional Height
- Credenzas include one adjustable shelf behind each door
- Equipment racks hold 12RU and include a thermostatically controlled fan and plug strip
- Refrigerators are Sold Separately

- Locks are Optional \$125 per Drawer/Bay
- Finished Back Available add15%
- Hardware options are in our Finishes and Hardware Guide
- Dura-Coat Solids Available at Same Price as Veneer

Casegoods *Compose* Credenzas

Compose Buffet Height Credenzas

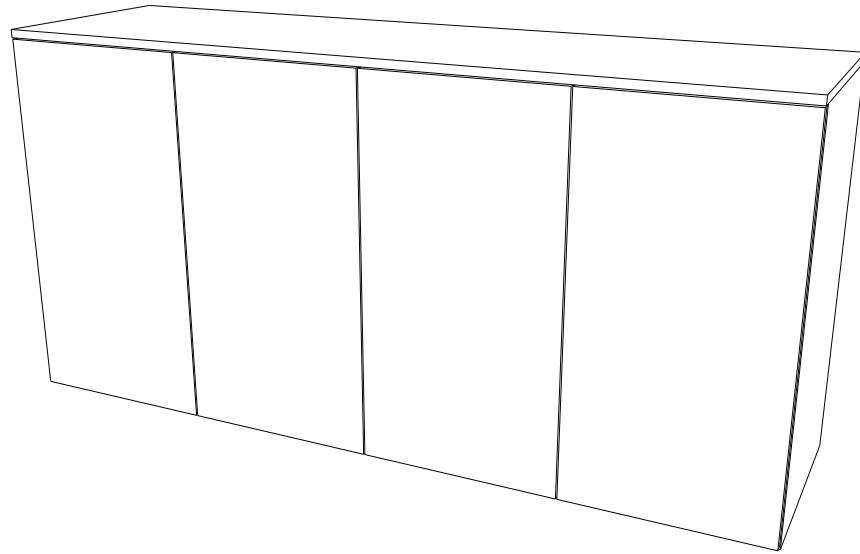

First choose the size of the credenza that suits you
Second Customize it to suit your specific needs with the components on the adjacent page.

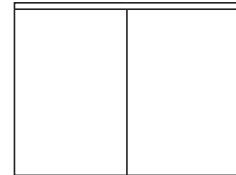

SIZE
36"W x 24"D x 36"H
Two Doors
MODEL #
CCBH 362436
VENEER \$5,682
LAMINATE \$4,546

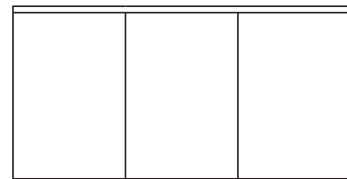

54"W x 24"D x 36"H
Three Doors
CCBH 542436
\$6,764
\$5,411

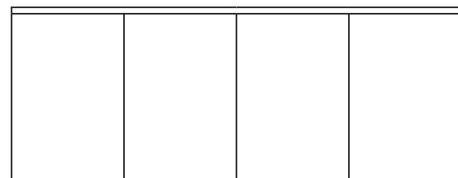

72"W x 24"D x 36"H
Four Doors
CCBH 722436
\$7,914
\$6,331

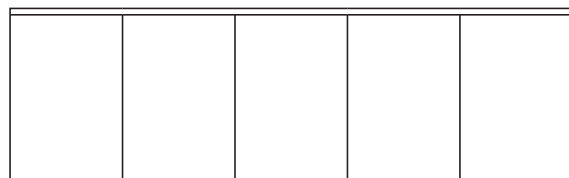

90"W x 24"D x 36"H
Five Doors
CCBH 902436
\$9,259
\$7,407

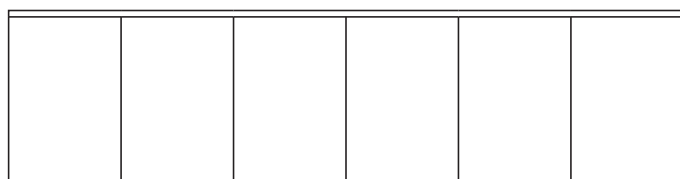

108"W x 24"D x 36"H
six doors
CCBH 1082436
\$10,832
\$8,666

Casegoods *Compose* Credenzas

Compose Buffet Height Floor Components Customize your Credenza

HINGED
DOOR/BOX DRAWER

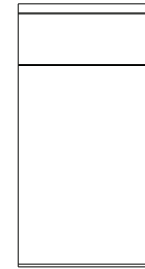

CBH HD
VENEER + \$582
LAMINATE + \$466

BOX
FILE FILE

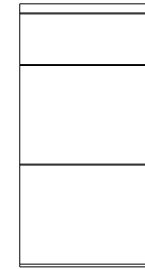

CBH BFF
VENEER + \$582
LAMINATE + \$466

FOUR
DRAWER

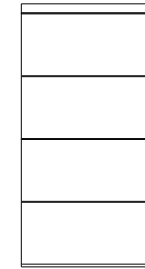

CBH 4D
VENEER + \$582
LAMINATE + \$466

OPEN ADJUSTABLE
SHELF



CBH AS
VENEER - \$497
LAMINATE - \$398

DOUBLE
HINGED DOOR/DRAWER

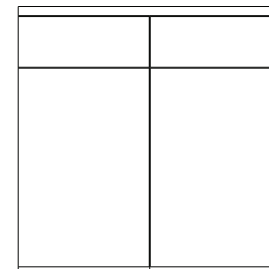

CBH 36 DHDD
VENEER + \$716
LAMINATE + \$573

LATERAL FILE
WITH DRAWER

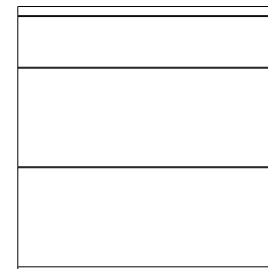

CBH 36 LAT
VENEER + \$716
LAMINATE + \$573

OPEN ADJUSTABLE
SHELVES

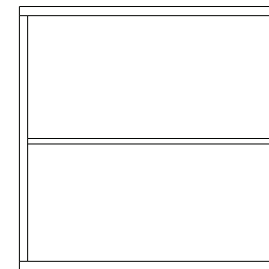

CBH 36 LAT
VENEER - \$497
LAMINATE - \$398

CPU
HOLDER
(WITH DOOR)

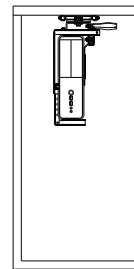

CPUH +\$472

HEAVY DUTY SLIDE OUT DOUBLE
TRASH/RECYCLING RECEPTACLE
(WITH DOOR)

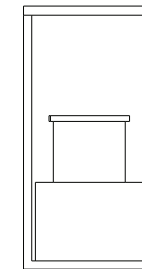

TRPO +\$1045

TEMPERATURE CONTROLLED
A/V UNIT
(WITH DOOR)

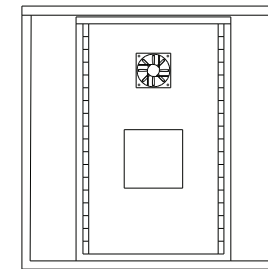

CCCAV
FIXED PLACE + \$1,171
SLIDE OUT + \$3,688

REFRIGERATOR STOW
(WITH DOOR)
*Refrigerator sold separately

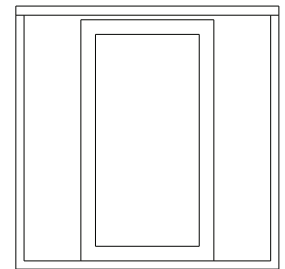

CCBHFRG \$0

COMPOSE TOP OPTIONS FOR 24" DEPTH	36" PRICE ADDER	54" PRICE ADDER	72" PRICE ADDER	90" PRICE ADDER	108" PRICE ADDER
GLASS	\$861	\$1,211	\$1,562	\$1,912	\$2,263
BACK PAINTED GLASS	\$1,563	\$2,265	\$2,966	\$3,667	\$4,369
SOLID SURFACE	\$1,745	\$2,928	\$4,111	\$4,984	\$5,856
RAISED KNIFE	\$199	\$290	\$381	\$472	\$563
STONE: MARBLE, GRANITE QUARTZ & KRYSTALCAST ARE AVAILABLE PLEASE CALL FOR PRICING					

General Information:

- Tops are 3/4"-thick. Specialty Tops add an Additional Height
- Credenzas include one adjustable shelf behind each door
- Equipment racks hold 12RU and include a thermostatically controlled fan and plug strip
- Refrigerators are Sold Separately

- Locks are Optional \$125 per Drawer/Bay
- Finished Back Available add15%
- Hardware options are in our Finishes and Hardware Guide
- Dura-Coat Solids Available at Same Price as Veneer

Casegoods *Compose* Credenzas

Compose Footed Buffet Height Credenzas

COLECRAFT

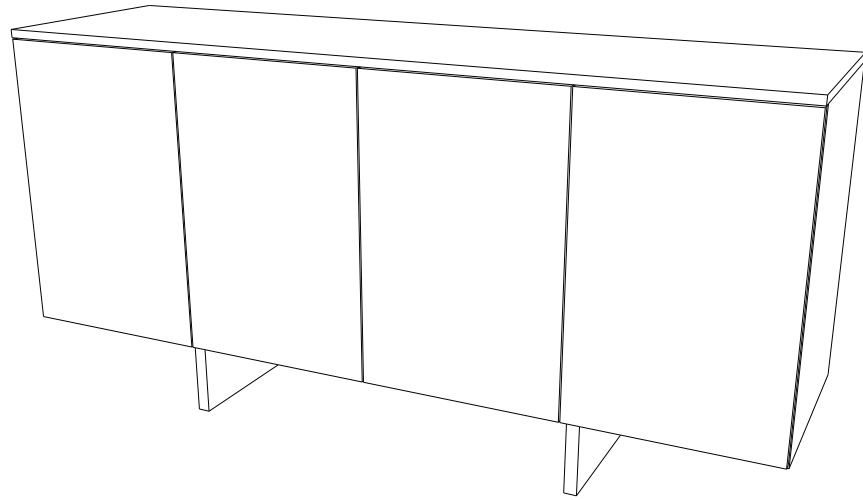

BRUSHED STAINLESS
BLADE



BSB

CONTEMPORARY
FOOT



CTF

First choose the size of the credenza that suits you
Second Customize it to suit your specific needs with the components on the adjacent page.

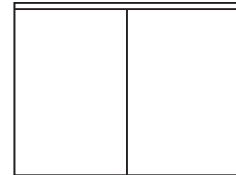

SIZE	Doors	MODEL #	VENEER	LAMINATE
36"W x 24"D x 36"H	Two Doors	CCFBH 362436	\$5,398	\$4,319

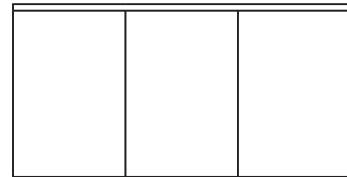

54"W x 24"D x 36"H	Three Doors	CCFBH 542436	\$6,426	\$5,140
--------------------	-------------	--------------	---------	---------

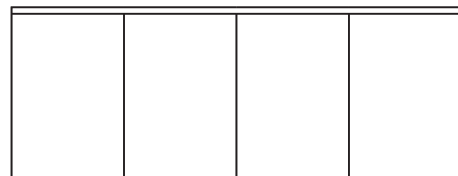

72"W x 24"D x 36"H	Four Doors	CCFBH 722436	\$7,519	\$6,015
--------------------	------------	--------------	---------	---------

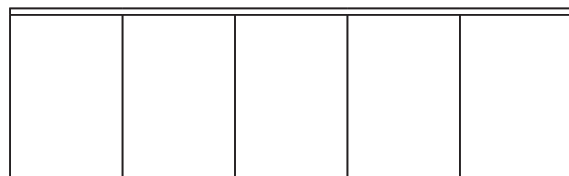

90"W x 24"D x 36"H	Five Doors	CCFBH 902436	\$8,796	\$7,037
--------------------	------------	--------------	---------	---------

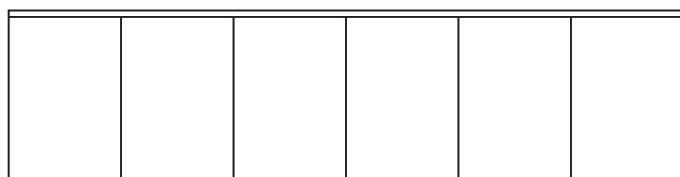

108"W x 24"D x 36"H	six doors	CCFBH 1082436	\$10,291	\$8,232
---------------------	-----------	---------------	----------	---------

Casegoods *Compose* Credenzas

Compose Buffet Height Floor Components Customize your Credenza

COLECRAFT

FILE FILE



CFF FF
VENEER + \$472
LAMINATE + \$389

BOX BOX FILE

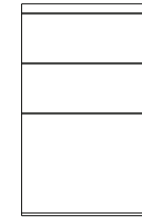

CFF BF
VENEER + \$472
LAMINATE + \$389

OPEN ADJUSTABLE
SHELF

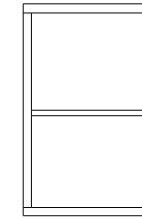

CFF AS
VENEER - \$414
LAMINATE - \$335

36" OPEN ADJUSTABLE
SHELF

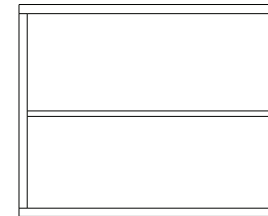

CFF AS 36
VENEER - \$414
LAMINATE - \$335

36" BOX BOX LATERAL

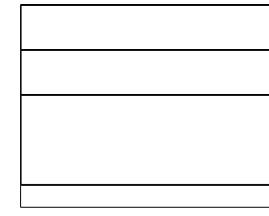

CFF BBL 36
VENEER + \$616
LAMINATE + \$493

36" LATERAL FILE

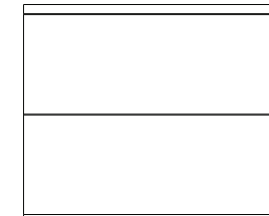

CFF LAT 36
VENEER + \$616
LAMINATE + \$493

CPU
HOLDER
(WITH DOOR)

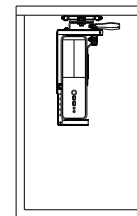

CPUH +\$472

HEAVY DUTY SLIDE OUT DOUBLE
TRASH/RECYCLING RECEPTACLE
(WITH DOOR)

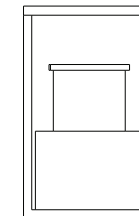

TRPO + \$1048

TEMPERATURE CONTROLLED
A/V UNIT
(WITH DOOR)

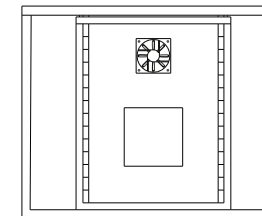

CCCAV
FIXED PLACE + \$1,171
SLIDE OUT + \$3,688

COMPOSE TOP OPTIONS FOR 24" DEPTH	36" PRICE ADDER	54"PRICE ADDER	72" PRICE ADDER	90" PRICE ADDER	108" PRICE ADDER
GLASS	\$861	\$1,211	\$1,562	\$1,912	\$2,263
BACK PAINTED GLASS	\$1,563	\$2,265	\$2,966	\$3,667	\$4,369
SOLID SURFACE	\$1,745	\$2,928	\$4,111	\$4,984	\$5,856
RAISED KNIFE	\$199	\$290	\$381	\$472	\$563
STONE: MARBLE, GRANITE QUARTZ & KRystalCAST ARE AVAILABLE PLEASE CALL FOR PRICING					

General Information:

- Tops are 3/4"-thick. Specialty Tops add an Additional Height
- Credenzas include one adjustable shelf behind each door
- Equipment racks hold 12RU and include a thermostatically controlled fan and plug strip
- Refrigerators are Sold Separately

- Locks are Optional \$125 per Drawer/Bay

- Finished Back Available add15%
- Hardware options are in our Finishes and Hardware Guide
- Dura-Coat Solids Available at Same Price as Veneer

Casegoods *Compose* Credenzas

Compose Conference Height Credenzas

COLECRAFT

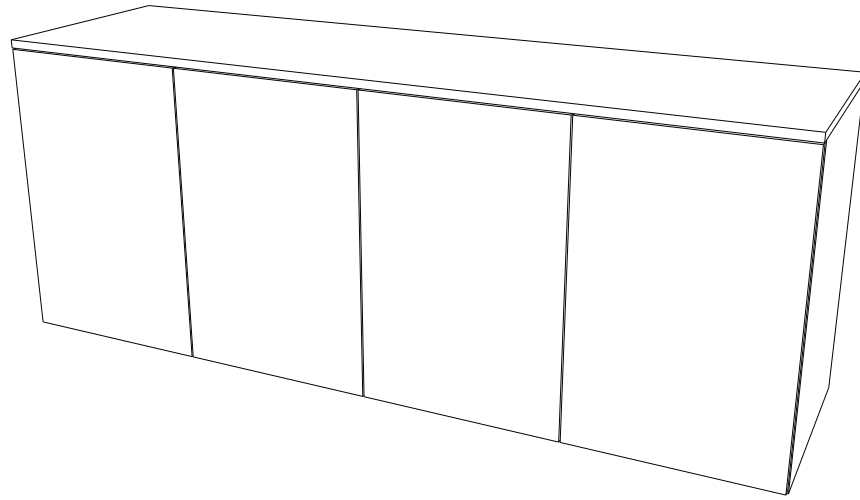

First choose the size of the credenza that suits you
Second Customize it to suit your specific needs with the components on the adjacent page.

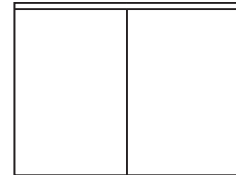

SIZE	Two Doors	MODEL #	VENEER	LAMINATE
36"W x 24"D x 29"H		CCCH 362429	\$4,548	\$3,638

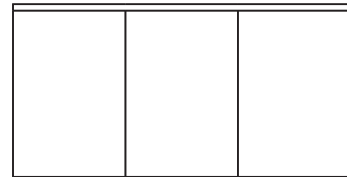

SIZE	Three Doors	MODEL #	VENEER	LAMINATE
54"W x 24"D x 29"H		CCCH 542429	\$5,410	\$4,328



SIZE	Four Doors	MODEL #	VENEER	LAMINATE
72"W x 24"D x 29"H		CCCH 722429	\$6,330	\$5,064

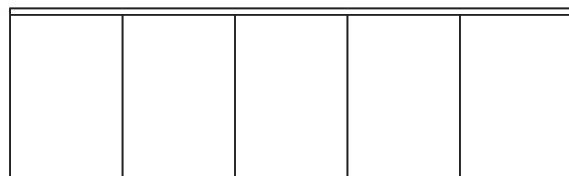

SIZE	Five Doors	MODEL #	VENEER	LAMINATE
90"W x 24"D x 29"H		CCCH 902429	\$7,408	\$5,926

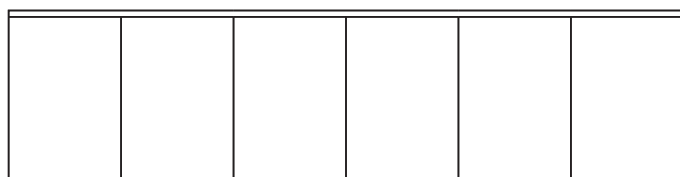

SIZE	six doors	MODEL #	VENEER	LAMINATE
108"W x 24"D x 29"H		CCCH 1082429	\$8,667	\$6,934

Casegoods *Compose* Credenzas

Compose Conference Height Credenza Components Customize your Credenza

COLECRAFT

FILE FILE



CFF FF
VENEER + \$472
LAMINATE + \$389

BOX BOX FILE

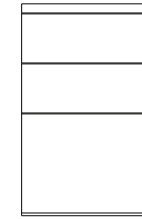

CFF BF
VENEER + \$472
LAMINATE + \$389

OPEN ADJUSTABLE SHELF

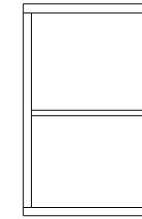

CFF AS
VENEER - \$414
LAMINATE - \$335

36" OPEN ADJUSTABLE SHELF

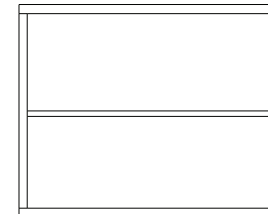

CFF AS 36
VENEER - \$414
LAMINATE - \$335

36" BOX BOX LATERAL

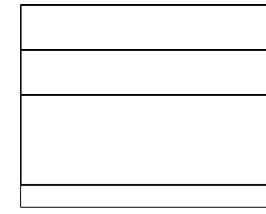

CFF BBL 36
VENEER + \$616
LAMINATE + \$493

36" LATERAL FILE

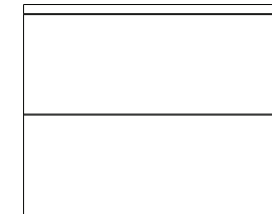

CFF LAT 36
VENEER + \$616
LAMINATE + \$493

CPU HOLDER (WITH DOOR)

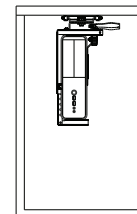

CPUH +\$472

HEAVY DUTY SLIDE OUT DOUBLE TRASH/RECYCLING RECEPTACLE (WITH DOOR)

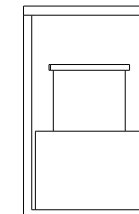

TRPO + \$1048

TEMPERATURE CONTROLLED A/V UNIT (WITH DOOR)

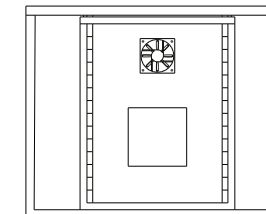

CCCAV
FIXED PLACE + \$1,171
SLIDE OUT + \$3,688

COMPOSE TOP OPTIONS FOR 24" DEPTH	36" PRICE ADDER	54"PRICE ADDER	72" PRICE ADDER	90" PRICE ADDER	108" PRICE ADDER
GLASS	\$861	\$1,211	\$1,562	\$1,912	\$2,263
BACK PAINTED GLASS	\$1,563	\$2,265	\$2,966	\$3,667	\$4,369
SOLID SURFACE	\$1,745	\$2,928	\$4,111	\$4,984	\$5,856
RAISED KNIFE	\$199	\$290	\$381	\$472	\$563
STONE: MARBLE, GRANITE QUARTZ & KRystalCAST ARE AVAILABLE PLEASE CALL FOR PRICING					

General Information:

- Tops are 3/4"-thick. Specialty Tops add an Additional Height
- Credenzas include one adjustable shelf behind each door
- Equipment racks hold 12RU and include a thermostatically controlled fan and plug strip
- Refrigerators are Sold Separately

- Locks are Optional \$125 per Drawer/Bay
- Finished Back Available add15%
- Hardware options are in our Finishes and Hardware Guide
- Dura-Coat Solids Available at Same Price as Veneer

Casegoods *Compose* Credenzas

Compose Footed Conference Height Credenzas

COLECRAFT

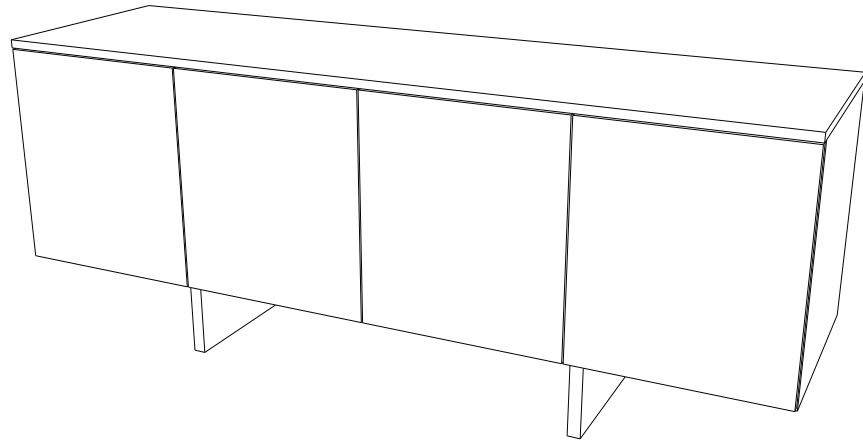

BRUSHED STAINLESS
BLADE



BSB

CONTEMPORARY
FOOT



CTF

First choose the size of the credenza that suits you
Second Customize it to suit your specific needs with the components on the adjacent page.

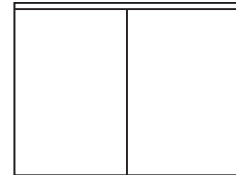

SIZE
36"W x 24"D x 29"H

Two Doors

MODEL #
CCFCH 362429

VENEER
\$4,320

LAMINATE
\$3,456

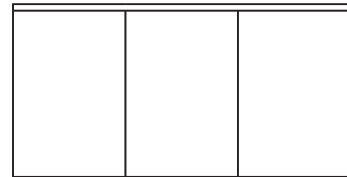

54"W x 24"D x 29"H

Three Doors

CCFCH 542429

\$5,140

\$4,112

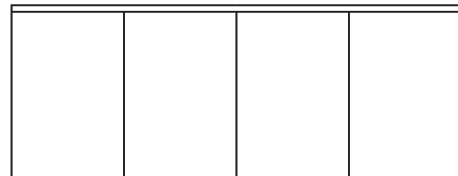

72"W x 24"D x 29"H

Four Doors

CCFCH 722429

\$6,014

\$4,811

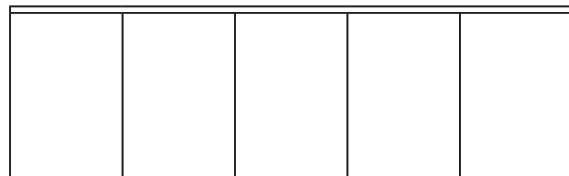

90"W x 24"D x 29"H

Five Doors

CCFCH 902429

\$7,037

\$5,630

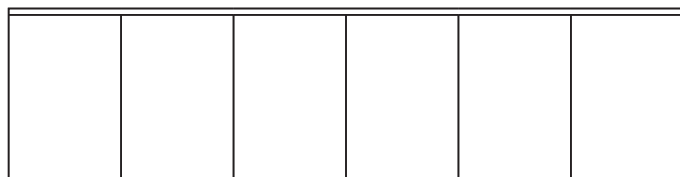

108"W x 24"D x 29"H

six doors

CCFCH 1082429

\$8,234

\$6,587

Casegoods *Compose* Credenzas

COLECRAFT

Compose footed Conference Height Credenza Components Customize your Credenza

OPEN ADJUSTABLE
SHELF

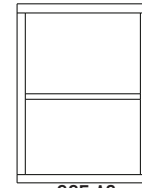

CCF AS
VENEER - \$365
LAMINATE - \$335

BOX FILE

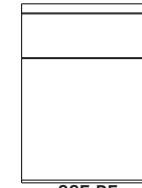

CCF BF
VENEER + \$431
LAMINATE + \$317

36" ADJUSTABLE
SHELF

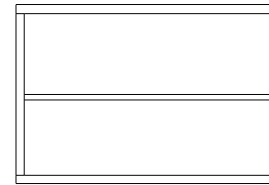

CCF AS 36
VENEER - \$365
LAMINATE - \$335

COMPOSE TOP OPTIONS FOR 24" DEPTH

	36" PRICE ADDER	54" PRICE ADDER	72" PRICE ADDER	90" PRICE ADDER	108" PRICE ADDER
GLASS	\$861	\$1,211	\$1,562	\$1,912	\$2,263
BACK PAINTED GLASS	\$1,563	\$2,265	\$2,966	\$3,667	\$4,369
SOLID SURFACE	\$1,745	\$2,928	\$4,111	\$4,984	\$5,856
RAISED KNIFE	\$199	\$290	\$381	\$472	\$563
STONE: MARBLE, GRANITE QUARTZ & KRYSTALCAST ARE AVAILABLE PLEASE CALL FOR PRICING					

General Information:

- Tops are 3/4"-thick. Specialty Tops add an Additional Height
- Credenzas include one adjustable shelf behind each door
- Equipment racks hold 12RU and include a thermostatically controlled fan and plug strip
- Refrigerators are Sold Separately

- Locks are Optional \$125 per Drawer/Bay
- Finished Back Available add15%
- Hardware options are in our Finishes and Hardware Guide
- Dura-Coat Solids Available at Same Price as Veneer

Compose Wall-Hung 18"H & Low Height Credenzas 24"H

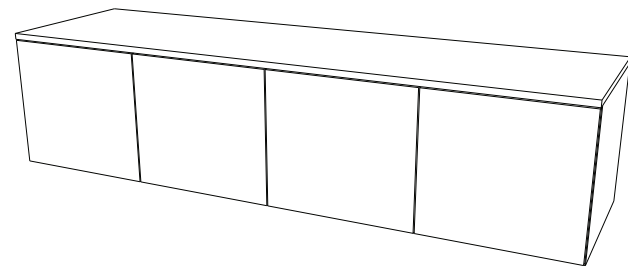
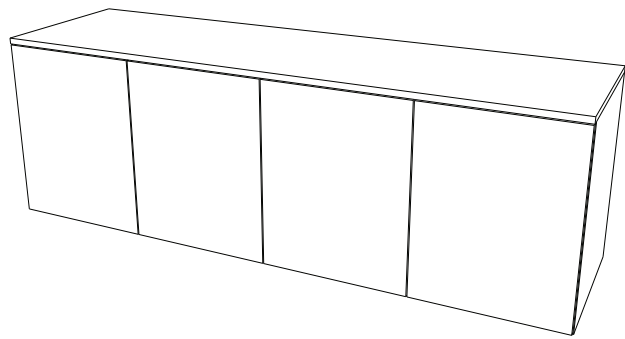

First choose the size of the credenza that suits you
Second Customize it to suit your specific needs with the components on the adjacent page.

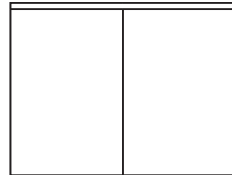

SIZE		MODEL #	VENEER	LAMINATE
36"W x 24"D x 24"H	Two Doors	CCLH 362424	\$3,684	\$2,947
36"W x 20"D x 18"H	Two Doors Wall Hung	CCWH 362018	\$2,615	\$2,092

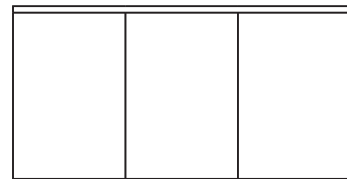

54"W x 24"D x 24"H	Three Doors	CCLH 542424	\$4,382	\$3,506
54"W x 20"D x 18"H	Three Doors Wall Hung	CCWH 542018	\$3,111	\$2,489

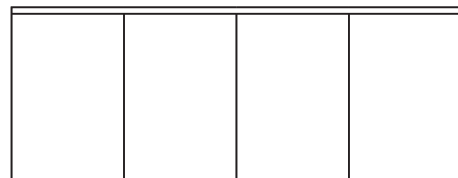

72"W x 24"D x 24"H	Four Doors	CCLH 722424	\$5,128	\$4,102
72"W x 20"D x 18"H	Four Doors Wall Hung	CCWH 722018	\$3,641	\$2,913

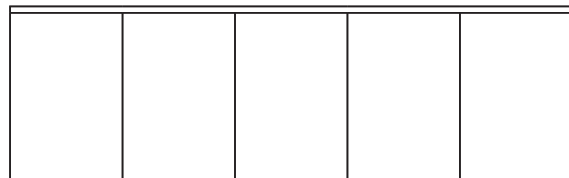

90"W x 24"D x 24"H	Five Doors	CCLH 902424	\$6,000	\$4,800
90"W x 20"D x 18"H	Five Doors Wall Hung	CCWH 902018	\$4,260	\$3,408

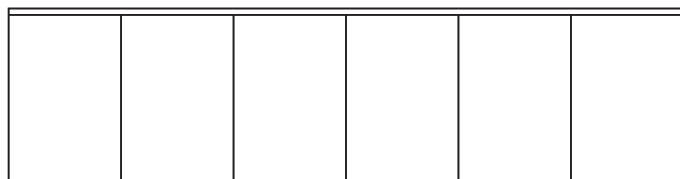

108"W x 24"D x 24"H	six doors	CCLH 1082424	\$7,020	\$5,616
108"W x 20"D x 18"H	six doors Wall Hung	CCWH 1082018	\$4,984	\$3,988

Compose Low Height Credenza Components Customize your Credenza

OPEN ADJUSTABLE SHELF



CLH AS
VENEER - \$365
LAMINATE - \$335

BOX FILE

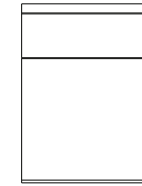

CLH BF
VENEER + \$431
LAMINATE + \$317

36" ADJUSTABLE SHELF

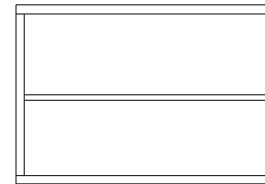

CLH AS 36
VENEER + \$431
LAMINATE + \$317

Compose Wall-Hung Credenza Components Customize your Credenza

DOUBLE DRAWER

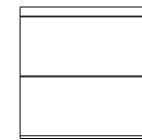

CWH DD
VENEER + \$431
LAMINATE + \$317

COMPOSE TOP OPTIONS FOR 20" DEPTH	36" PRICE ADDER	54"PRICE ADDER	72" PRICE ADDER	90" PRICE ADDER	108" PRICE ADDER
GLASS	\$745	\$1,037	\$1,330	\$1,622	\$1,915
BACK PAINTED GLASS	\$1,330	\$1,915	\$2,500	\$3,085	\$3,670
SOLID SURFACE	\$1,558	\$2,647	\$3,737	\$4,516	\$5,294
RAISED KNIFE	\$196	\$287	\$378	\$469	\$560
STONE: MARBLE, GRANITE QUARTZ & KRYSTALCAST ARE AVAILABLE PLEASE CALL FOR PRICING					

COMPOSE TOP OPTIONS FOR 24" DEPTH	36" PRICE ADDER	54"PRICE ADDER	72" PRICE ADDER	90" PRICE ADDER	108" PRICE ADDER
GLASS	\$861	\$1,211	\$1,562	\$1,912	\$2,263
BACK PAINTED GLASS	\$1,563	\$2,265	\$2,966	\$3,667	\$4,369
SOLID SURFACE	\$1,745	\$2,928	\$4,111	\$4,984	\$5,856
RAISED KNIFE	\$199	\$290	\$381	\$472	\$563
STONE: MARBLE, GRANITE QUARTZ & KRYSTALCAST ARE AVAILABLE PLEASE CALL FOR PRICING					

General Information:

- Tops are 3/4"-thick. Specialty Tops add an Additional Height
- Credenzas include one adjustable shelf behind each door
- Equipment racks hold 12RU and include a thermostatically controlled fan and plug strip
- Refrigerators are Sold Separately

- Locks are Optional \$125 per Drawer/Bay
- Finished Back Available add15%
- Hardware options are in our Finishes and Hardware Guide
- Dura-Coat Solids Available at Same Price as Veneer

Casegoods Public Spaces

Classic 4 Post Parsons 16"/20" Height

COLECRAFT

DIMENSIONS	16"			20"		
	MODEL #	PRICE LM	PRICE VN	MODEL #	PRICE LM	PRICE VN
24"W X 60"D	CP 246016	\$4,686	\$6,609	CP 246020	\$4,881	\$6,884
24"W X 72"D	CP 247216	\$4,760	\$6,743	CP 247220	\$4,958	\$7,024
24"W X 84"D	CP 248416	\$5,152	\$7,749	CP 248420	\$5,367	\$8,072
24"W X 96"D	CP 249616	\$6,178	\$9,207	CP 249620	\$6,435	\$9,591
24"W X 120"D	CP 2412016	\$6,646	\$10,014	CP 2412020	\$6,923	\$10,431
30"W X 60"D	CP 306016	\$4,757	\$6,677	CP 306020	\$4,955	\$6,955
30"W X 72"D	CP 307216	\$4,852	\$6,828	CP 307220	\$5,054	\$7,113
30"W X 84"D	CP 308416	\$5,258	\$7,862	CP 308420	\$5,477	\$8,190
30"W X 96"D	CP 309616	\$6,285	\$9,321	CP 309620	\$6,547	\$9,709
30"W X 120"D	CP 3012016	\$6,634	\$10,099	CP 3012020	\$6,910	\$10,520
36"W X 60"D	CP 366016	\$4,828	\$7,202	CP 366020	\$5,029	\$7,502
36"W X 72"D	CP 367216	\$4,946	\$7,380	CP 367220	\$5,152	\$7,687
36"W X 84"D	CP 368416	\$5,366	\$8,292	CP 368420	\$5,589	\$8,638
36"W X 96"D	CP 369616	\$6,391	\$9,997	CP 369620	\$6,658	\$10,413
36"W X 120"D	CP 3612016	\$6,773	\$10,586	CP 3612020	\$7,055	\$11,027
42"W X 60"D	CP 426016	\$5,340	\$7,989	CP 426020	\$5,563	\$8,322
42"W X 72"D	CP 427216	\$5,396	\$8,224	CP 427220	\$5,621	\$8,567
42"W X 84"D	CP 428416	\$6,041	\$9,266	CP 428420	\$6,293	\$9,652
42"W X 96"D	CP 429616	\$7,069	\$10,782	CP 429620	\$7,363	\$11,232
42"W X 120"D	CP 4212016	\$7,378	\$11,636	CP 4212020	\$7,685	\$12,121

NOTE: Dura-Coat Available at the same price as Veneer

Casegoods Public Spaces

Classic 4 Post Parsons 29"/36"/42" Height

COLECRAFT

DIMENSIONS	29"			36"			42"		
	MODEL #	PRICE LM	PRICE VN	MODEL #	PRICE LM	PRICE VN	MODEL #	PRICE LM	PRICE VN
24"W X 60"D	CP 246029	\$5,084	\$7,171	CP 246036	\$4,655	\$7,212	CP 246042	\$5,234	\$7,337
24"W X 72"D	CP 247229	\$5,165	\$7,317	CP 247236	\$4,703	\$7,325	CP 247242	\$5,285	\$7,450
24"W X 84"D	CP 248429	\$5,591	\$8,408	CP 248436	\$5,118	\$8,453	CP 248442	\$5,748	\$8,597
24"W X 96"D	CP 249629	\$6,703	\$9,990	CP 249636	\$6,130	\$10,037	CP 249642	\$6,861	\$10,179
24"W X 120"D	CP 2412029	\$7,211	\$10,865	CP 2412036	\$6,442	\$10,911	CP 2412042	\$7,205	\$11,055
30"W X 60"D	CP 306029	\$5,162	\$7,245	CP 306036	\$4,715	\$7,274	CP 306042	\$5,316	\$7,420
30"W X 72"D	CP 307229	\$5,265	\$7,409	CP 307236	\$4,797	\$7,422	CP 307242	\$5,406	\$7,566
30"W X 84"D	CP 308429	\$5,706	\$8,531	CP 308436	\$5,211	\$8,562	CP 308442	\$5,868	\$8,726
30"W X 96"D	CP 309629	\$6,820	\$10,113	CP 309636	\$6,224	\$10,144	CP 309642	\$6,983	\$10,309
30"W X 120"D	CP 3012029	\$7,198	\$10,958	CP 3012036	\$6,568	\$10,989	CP 3012042	\$7,361	\$11,151
36"W X 60"D	CP 366029	\$5,239	\$7,814	CP 366036	\$5,252	\$8,300	CP 366042	\$5,398	\$8,005
36"W X 72"D	CP 367229	\$5,367	\$8,007	CP 367236	\$5,380	\$8,505	CP 367242	\$5,526	\$8,198
36"W X 84"D	CP 368429	\$5,822	\$8,998	CP 368436	\$5,835	\$9,555	CP 368442	\$5,990	\$9,207
36"W X 96"D	CP 369629	\$6,935	\$10,847	CP 369636	\$6,948	\$11,300	CP 369642	\$7,103	\$10,853
36"W X 120"D	CP 3612029	\$7,349	\$11,486	CP 3612036	\$7,363	\$12,195	CP 3612042	\$7,159	\$11,987
42"W X 60"D	CP 426029	\$5,794	\$8,669	CP 426036	\$5,327	\$8,749	CP 426042	\$6,015	\$8,932
42"W X 72"D	CP 427229	\$5,855	\$8,924	CP 427236	\$5,339	\$8,944	CP 427242	\$6,026	\$9,129
42"W X 84"D	CP 428429	\$6,555	\$10,054	CP 428436	\$5,976	\$10,076	CP 428442	\$6,736	\$10,280
42"W X 96"D	CP 429629	\$7,670	\$11,700	CP 429636	\$6,989	\$11,722	CP 429642	\$7,849	\$11,926
42"W X 120"D	CP 4212029	\$8,005	\$12,626	CP 4212036	\$7,294	\$12,649	CP 4212042	\$8,184	\$12,852

NOTE: Dura-Coat Available at the same price as Veneer

Casegoods Public Spaces

Panel Leg Parsons Table 16"/20" Height

COLECRAFT

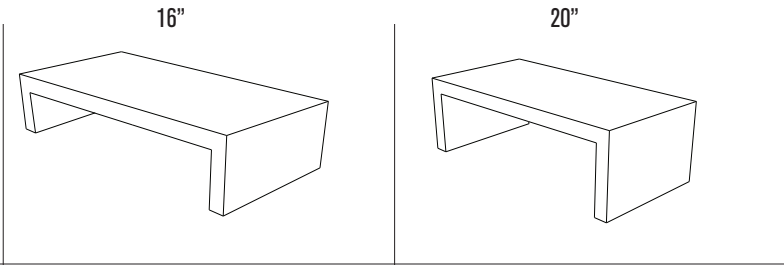

DIMENSIONS	MODEL #	PRICE LM	PRICE VN	MODEL #	PRICE LM	PRICE VN
24"W X 60"D	PP 246016	\$4,686	\$6,609	PP 246020	\$4,881	\$6,885
24"W X 72"D	PP 247216	\$4,760	\$6,743	PP 247220	\$4,958	\$7,025
24"W X 84"D	PP 248416	\$5,152	\$7,749	PP 248420	\$5,367	\$8,072
24"W X 96"D	PP 249616	\$6,177	\$9,207	PP 249620	\$6,435	\$9,590
24"W X 120"D	PP 2412016	\$6,645	\$10,014	PP 2412020	\$6,923	\$10,430
30"W X 60"D	PP 306016	\$4,758	\$6,678	PP 306020	\$4,955	\$6,956
30"W X 72"D	PP 307216	\$4,852	\$6,829	PP 307220	\$5,054	\$7,112
30"W X 84"D	PP 308416	\$5,258	\$7,863	PP 308420	\$5,478	\$8,190
30"W X 96"D	PP 309616	\$6,285	\$9,321	PP 309620	\$6,548	\$9,709
30"W X 120"D	PP 3012016	\$6,634	\$10,099	PP 3012020	\$6,910	\$10,519
36"W X 60"D	PP 366016	\$4,827	\$7,201	PP 366020	\$5,030	\$7,501
36"W X 72"D	PP 367216	\$4,947	\$7,380	PP 367220	\$5,152	\$7,687
36"W X 84"D	PP 368416	\$5,366	\$8,292	PP 368420	\$5,590	\$8,638
36"W X 96"D	PP 369616	\$6,391	\$9,996	PP 369620	\$6,657	\$10,414
36"W X 120"D	PP 3612016	\$6,773	\$10,585	PP 3612020	\$7,056	\$11,027
42"W X 60"D	PP 426016	\$5,341	\$7,989	PP 426020	\$5,562	\$8,321
42"W X 72"D	PP 427216	\$5,396	\$8,225	PP 427220	\$5,622	\$8,567
42"W X 84"D	PP 428416	\$6,042	\$9,265	PP 428420	\$6,293	\$9,652
42"W X 96"D	PP 429616	\$7,069	\$10,783	PP 429620	\$7,363	\$11,232
42"W X 120"D	PP 4212016	\$7,377	\$11,636	PP 4212020	\$7,685	\$12,121

NOTE: Dura-Coat Available at the same price as Veneer

Casegoods Public Spaces

Panel Leg Parsons Table 29"/36"/42" Height

COLECRAFT

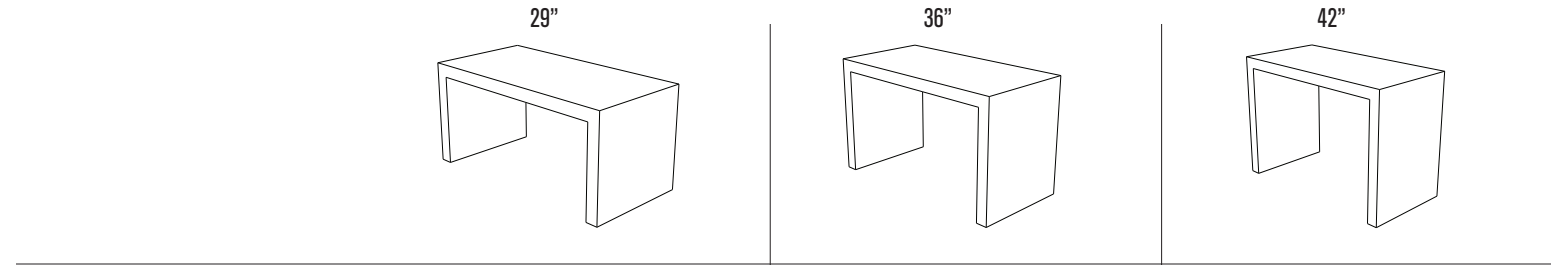

DIMENSIONS	MODEL #	PRICE LM	PRICE VN	MODEL #	PRICE LM	PRICE VN	MODEL #	PRICE LM	PRICE VN	MODEL #	PRICE LM	PRICE VN
24"W X 60"D	PP 246029	\$5,084	\$5,737	PP 246036	\$5,120	\$5,770	PP 246042	\$5,234	\$5,870			
24"W X 72"D	PP 247229	\$5,165	\$5,854	PP 247236	\$5,173	\$5,860	PP 247242	\$5,285	\$5,960			
24"W X 84"D	PP 248429	\$5,591	\$6,726	PP 248436	\$5,630	\$6,763	PP 248442	\$5,748	\$6,878			
24"W X 96"D	PP 249629	\$6,703	\$7,992	PP 249636	\$6,743	\$8,030	PP 249642	\$6,861	\$8,143			
24"W X 120"D	PP 2412029	\$7,211	\$8,692	PP 2412036	\$7,086	\$8,729	PP 2412042	\$7,205	\$8,844			
30"W X 60"D	PP 306029	\$5,162	\$5,796	PP 306036	\$5,186	\$5,819	PP 306042	\$5,316	\$5,936			
30"W X 72"D	PP 307229	\$5,265	\$5,928	PP 307236	\$5,277	\$5,937	PP 307242	\$5,406	\$6,052			
30"W X 84"D	PP 308429	\$5,706	\$6,825	PP 308436	\$5,732	\$6,850	PP 308442	\$5,868	\$6,981			
30"W X 96"D	PP 309629	\$6,820	\$8,091	PP 309636	\$6,846	\$8,115	PP 309642	\$6,983	\$8,247			
30"W X 120"D	PP 3012029	\$7,198	\$8,766	PP 3012036	\$7,224	\$8,791	PP 3012042	\$7,361	\$8,921			
36"W X 60"D	PP 366029	\$5,239	\$6,251	PP 366036	\$5,252	\$6,264	PP 366042	\$5,398	\$6,404			
36"W X 72"D	PP 367229	\$5,367	\$6,406	PP 367236	\$5,380	\$6,419	PP 367242	\$5,526	\$6,559			
36"W X 84"D	PP 368429	\$5,822	\$7,198	PP 368436	\$5,835	\$7,211	PP 368442	\$5,990	\$7,366			
36"W X 96"D	PP 369629	\$6,935	\$8,678	PP 369636	\$6,948	\$8,528	PP 369642	\$7,103	\$8,683			
36"W X 120"D	PP 3612029	\$7,349	\$9,189	PP 3612036	\$7,363	\$9,204	PP 3612042	\$7,517	\$10,069			
42"W X 60"D	PP 426029	\$5,794	\$6,935	PP 426036	\$5,860	\$6,999	PP 426042	\$6,015	\$7,146			
42"W X 72"D	PP 427229	\$5,855	\$7,139	PP 427236	\$5,873	\$7,155	PP 427242	\$6,026	\$7,303			
42"W X 84"D	PP 428429	\$6,555	\$8,043	PP 428436	\$6,574	\$8,061	PP 428442	\$6,736	\$8,224			
42"W X 96"D	PP 429629	\$7,670	\$9,360	PP 429636	\$7,688	\$9,378	PP 429642	\$7,849	\$9,541			
42"W X 120"D	PP 4212029	\$8,005	\$10,101	PP 4212036	\$8,023	\$10,119	PP 4212042	\$8,184	\$10,282			

NOTE: Dura-Coat Available at the same price as Veneer

Casegoods Public Spaces

COLECRAFT

Contemporary Waterfall Tables 16"/20" Height

DIMENSIONS	16"			20"		
	MODEL #	PRICE LM	PRICE VN	MODEL #	PRICE LM	PRICE VN
24"W X 60"D	CW 246016	\$6,091	\$8,591	CW 246020	\$6,345	\$8,949
24"W X 72"D	CW 247216	\$6,188	\$8,766	CW 247220	\$6,446	\$9,132
24"W X 84"D	CW 248416	\$6,698	\$10,073	CW 248420	\$6,977	\$10,493
24"W X 96"D	CW 249616	\$8,031	\$11,969	CW 249620	\$8,366	\$12,468
24"W X 120"D	CW 2412016	\$8,640	\$13,018	CW 2412020	\$9,000	\$13,560
30"W X 60"D	CW 306016	\$6,184	\$8,680	CW 306020	\$6,442	\$9,042
30"W X 72"D	CW 307216	\$6,308	\$8,877	CW 307220	\$6,571	\$9,247
30"W X 84"D	CW 308416	\$6,836	\$10,221	CW 308420	\$7,121	\$10,647
30"W X 96"D	CW 309616	\$8,171	\$12,117	CW 309620	\$8,511	\$12,622
30"W X 120"D	CW 3012016	\$8,624	\$13,128	CW 3012020	\$8,983	\$13,676
36"W X 60"D	CW 366016	\$6,276	\$9,362	CW 366020	\$6,538	\$9,752
36"W X 72"D	CW 367216	\$6,430	\$9,593	CW 367220	\$6,698	\$9,993
36"W X 84"D	CW 368416	\$6,976	\$10,780	CW 368420	\$7,266	\$11,229
36"W X 96"D	CW 369616	\$8,309	\$12,996	CW 369620	\$8,655	\$13,537
36"W X 120"D	CW 3612016	\$8,805	\$13,761	CW 3612020	\$9,172	\$14,335
42"W X 60"D	CW 426016	\$6,942	\$10,386	CW 426020	\$7,231	\$10,819
42"W X 72"D	CW 427216	\$7,015	\$10,691	CW 427220	\$7,307	\$11,137
42"W X 84"D	CW 428416	\$7,854	\$12,045	CW 428420	\$8,181	\$12,547
42"W X 96"D	CW 429616	\$9,189	\$14,017	CW 429620	\$9,572	\$14,601
42"W X 120"D	CW 4212016	\$9,591	\$15,127	CW 4212020	\$9,991	\$15,758

NOTE: Dura-Coat Available at the same price as Veneer

Casegoods Public Spaces

COLECRAFT

Contemporary Waterfall Tables 29"/36"/42" Height

DIMENSIONS	29"			36"			42"		
	MODEL #	PRICE LM	PRICE VN	MODEL #	PRICE LM	PRICE VN	MODEL #	PRICE LM	PRICE VN
24"W X 60"D	CW 246029	\$6,610	\$7,458	CW 246036	\$6,657	\$7,501	CW 246042	\$6,804	\$7,631
24"W X 72"D	CW 247229	\$6,714	\$7,610	CW 247236	\$6,725	\$7,618	CW 247242	\$6,870	\$7,749
24"W X 84"D	CW 248429	\$7,268	\$8,744	CW 248436	\$7,319	\$8,791	CW 248442	\$7,473	\$8,941
24"W X 96"D	CW 249629	\$8,714	\$10,390	CW 249636	\$8,766	\$10,439	CW 249642	\$8,920	\$10,586
24"W X 120"D	CW 2412029	\$9,375	\$11,300	CW 2412036	\$9,212	\$11,347	CW 2412042	\$9,366	\$11,497
30"W X 60"D	CW 306029	\$6,710	\$7,535	CW 306036	\$6,742	\$7,565	CW 306042	\$6,911	\$7,716
30"W X 72"D	CW 307229	\$6,845	\$7,706	CW 307236	\$6,860	\$7,719	CW 307242	\$7,028	\$7,868
30"W X 84"D	CW 308429	\$7,417	\$8,873	CW 308436	\$7,451	\$8,905	CW 308442	\$7,629	\$9,076
30"W X 96"D	CW 309629	\$8,866	\$10,518	CW 309636	\$8,900	\$10,550	CW 309642	\$9,078	\$10,721
30"W X 120"D	CW 3012029	\$9,358	\$11,396	CW 3012036	\$9,392	\$11,428	CW 3012042	\$9,569	\$11,597
36"W X 60"D	CW 366029	\$6,810	\$8,127	CW 366036	\$6,827	\$8,144	CW 366042	\$7,018	\$8,325
36"W X 72"D	CW 367229	\$6,977	\$8,328	CW 367236	\$6,994	\$8,345	CW 367242	\$7,184	\$8,526
36"W X 84"D	CW 368429	\$7,569	\$9,358	CW 368436	\$7,586	\$9,375	CW 368442	\$7,787	\$9,576
36"W X 96"D	CW 369629	\$9,016	\$11,281	CW 369636	\$9,033	\$11,086	CW 369642	\$9,234	\$11,287
36"W X 120"D	CW 3612029	\$9,554	\$11,945	CW 3612036	\$9,571	\$11,965	CW 3612042	\$9,772	\$11,901
42"W X 60"D	CW 426029	\$7,533	\$9,016	CW 426036	\$7,618	\$9,099	CW 426042	\$7,819	\$9,289
42"W X 72"D	CW 427229	\$7,612	\$9,281	CW 427236	\$7,635	\$9,302	CW 427242	\$7,834	\$9,494
42"W X 84"D	CW 428429	\$8,522	\$10,456	CW 428436	\$8,546	\$10,480	CW 428442	\$8,757	\$10,691
42"W X 96"D	CW 429629	\$9,971	\$12,168	CW 429636	\$9,994	\$12,191	CW 429642	\$10,204	\$12,403
42"W X 120"D	CW 4212029	\$10,407	\$13,131	CW 4212036	\$10,430	\$13,155	CW 4212042	\$10,640	\$13,367

NOTE: Dura-Coat Available at the same price as Veneer

Casegoods Public Spaces

Adjustable Height Parsons Table 29" – 42" Height

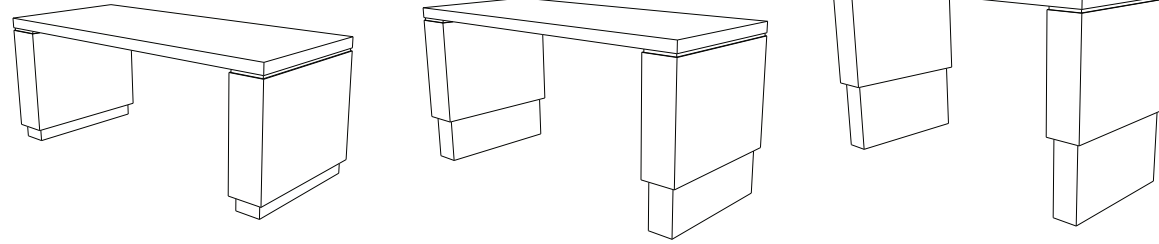

DIMENSIONS	MODEL #	PRICE LM	PRICE VN
24"W X 60"D X 31"/42"H	AHP 2460AH	\$13,669	\$15,403
24"W X 72"D X 31"/42"H	AHP 2472AH	\$13,730	\$15,508
24"W X 84"D X 31"/42"H	AHP 2484AH	\$15,336	\$17,244
24"W X 96"D X 31"/42"H	AHP 2496AH	\$15,424	\$17,340
30"W X 60"D X 31"/42"H	AHP 3060AH	\$13,727	\$15,457
30"W X 72"D X 31"/42"H	AHP 3072AH	\$13,806	\$15,572
30"W X 84"D X 31"/42"H	AHP 3084AH	\$15,426	\$17,330
30"W X 96"D X 31"/42"H	AHP 3096AH	\$15,516	\$17,425
36"W X 60"D X 31"/42"H	AHP 3660AH	\$14,405	\$16,159
36"W X 72"D X 31"/42"H	AHP 3672AH	\$14,500	\$16,286
36"W X 84"D X 31"/42"H	AHP 3684AH	\$16,203	\$18,134
36"W X 96"D X 31"/42"H	AHP 3696AH	\$16,291	\$18,229
42"W X 60"D X 31"/42"H	AHP 4260AH	\$14,820	\$16,722
42"W X 72"D X 31"/42"H	AHP 4272AH	\$14,866	\$16,891
42"W X 84"D X 31"/42"H	AHP 4284AH	\$16,780	\$18,847
42"W X 96"D X 31"/42"H	AHP 4296AH	\$16,872	\$18,927

COLECRAFT

Casegoods

Standing Height Multi Use Lectern

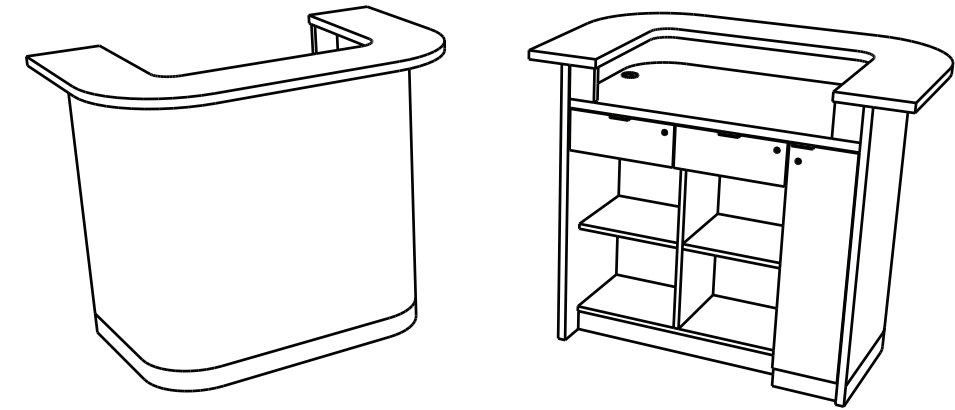

MODEL #	DIMENSIONS	LAMINATE (LM)	VENEER (VN)
PFST_363142	31"W X 31"D X 42"H	\$4,672	\$6,378
PFST_523142	52"W X 31"D X 42"H	\$5,110	\$6,976
PFST_723142	72"W X 31"D X 42"H	\$5,548	\$7,574

COLECRAFT

NOTE: Dura-Coat Available at the same price as Veneer

Casegoods Public Spaces

Cube Tables

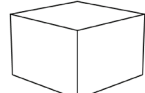
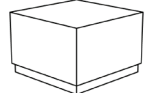
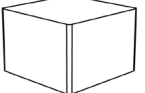
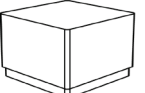
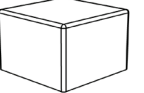
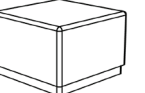
MODEL #	DIMENSIONS						
		SQ. CORNER W/O BASE (CU)	SQ. CORNER W/ BASE (CUB)	SOFTLINE RADIUS W/O BASE (SLCU)	SOFTLINE RADIUS W/BASE (SLCUB)	WOOD BORDER W/O BASE (WBCU)	WOOD BORDER W/ BASE (WBCUB)
L1616	16"W X 16"D X 16"H	\$1,097	\$1,438	\$1,574	\$1,988	\$2,467	\$2,871
V1616	16"W X 16"D X 16"H	\$1,697	\$2,012	\$2,090	\$2,488	\$2,926	\$3,283
L1620	16"W X 16"D X 20"D	\$1,151	\$1,533	\$1,693	\$2,112	\$2,577	\$2,984
V1620	16"W X 16"D X 20"D	\$1,852	\$2,148	\$2,237	\$2,631	\$3,067	\$3,452
L1624	16"W X 16"D X 24"D	\$1,253	\$1,621	\$1,805	\$2,222	\$2,690	\$3,101
V1624	16"W X 16"D X 24"D	\$2,033	\$2,324	\$2,367	\$2,762	\$3,194	\$3,596
L2016	20"W X 20"D X 16"D	\$1,302	\$1,688	\$1,805	\$2,271	\$2,871	\$3,337
V2016	20"W X 20"D X 16"D	\$2,044	\$2,365	\$2,367	\$2,813	\$3,369	\$3,802
L2020	20"W X 20"D X 20"D	\$1,423	\$1,820	\$1,942	\$2,410	\$3,013	\$3,428
V2020	20"W X 20"D X 20"D	\$2,246	\$2,560	\$2,501	\$2,948	\$3,505	\$3,924
L2024	20"W X 20"D X 24"H	\$1,533	\$1,893	\$1,997	\$2,467	\$3,067	\$3,524
V2024	20"W X 20"D X 24"H	\$2,427	\$2,741	\$2,652	\$3,101	\$3,647	\$4,073
L2416	24"W X 24"D X 16"H	\$1,401	\$1,765	\$1,854	\$2,369	\$3,101	\$3,609
V2416	24"W X 24"D X 16"H	\$2,156	\$2,482	\$2,433	\$2,920	\$3,647	\$4,073
L2420	24"W X 24"D X 20"H	\$1,489	\$1,893	\$1,997	\$2,524	\$3,254	\$3,715
V2420	24"W X 24"D X 20"H	\$2,378	\$2,696	\$2,577	\$3,082	\$3,751	\$4,221
L2424	24"W X 24"D X 24"H	\$1,608	\$2,005	\$2,056	\$2,577	\$3,307	\$3,811
V2424	24"W X 24"D X 24"H	\$2,569	\$2,886	\$2,729	\$3,226	\$3,890	\$4,379
L3016	30"W X 30"D X 16"H	\$1,867	\$2,248	\$2,103	\$2,680	\$3,637	\$4,187
V3016	30"W X 30"D X 16"H	\$2,922	\$3,269	\$3,007	\$3,605	\$4,213	\$4,738
L3020	30"W X 30"D X 20"H	\$2,014	\$2,410	\$2,222	\$2,803	\$3,736	\$4,294
V3020	30"W X 30"D X 20"H	\$3,135	\$3,471	\$3,147	\$3,743	\$4,334	\$4,862
L3024	30"W X 30"D X 24"H	\$2,148	\$2,554	\$2,312	\$2,890	\$3,834	\$4,392
V3024	30"W X 30"D X 24"H	\$3,347	\$3,673	\$3,292	\$3,900	\$4,468	\$4,995
L3616	36"W X 36"D X 16"H	\$2,169	\$2,618	\$2,410	\$3,052	\$4,300	\$4,915
V3616	36"W X 36"D X 16"H	\$3,502	\$3,845	\$3,705	\$4,398	\$4,968	\$5,534
L3620	36"W X 36"D X 20"H	\$2,344	\$2,763	\$2,524	\$3,156	\$4,411	\$5,123
V3620	36"W X 36"D X 20"H	\$3,741	\$4,085	\$3,877	\$4,576	\$5,100	\$5,727
L3624	36"W X 36"D X 24"H	\$2,410	\$2,839	\$2,622	\$3,264	\$4,506	\$5,272
V3624	36"W X 36"D X 24"H	\$3,951	\$4,298	\$4,038	\$4,721	\$5,244	\$5,818
L4216	42"W X 42"D X 16"H	\$2,903	\$3,332	\$3,609	\$4,543	\$5,742	\$6,676
V4216	42"W X 42"D X 16"H	\$4,557	\$4,910	\$4,736	\$5,627	\$6,741	\$7,601
L4220	42"W X 42"D X 20"H	\$3,058	\$3,483	\$3,887	\$4,821	\$6,023	\$6,856
V4220	42"W X 42"D X 20"H	\$4,806	\$5,168	\$5,004	\$5,895	\$7,009	\$7,849
L4224	42"W X 42"D X 24"H	\$3,230	\$3,658	\$3,992	\$4,936	\$6,135	\$7,048
V4224	42"W X 42"D X 24"H	\$5,104	\$5,463	\$5,302	\$6,203	\$7,296	\$8,149
L4816	48"W X 48"D X 16"H	\$3,156	\$3,598	\$3,707	\$4,740	\$6,203	\$7,218
V4816	48"W X 48"D X 16"H	\$5,027	\$5,391	\$4,868	\$5,840	\$7,296	\$8,149
L4820	48"W X 48"D X 20"H	\$3,300	\$3,770	\$3,992	\$5,047	\$6,510	\$7,432
V4820	48"W X 48"D X 20"H	\$5,321	\$5,697	\$5,153	\$6,165	\$7,499	\$8,443
L4824	48"W X 48"D X 24"H	\$3,530	\$3,981	\$4,113	\$5,153	\$6,612	\$7,624
V4824	48"W X 48"D X 24"H	\$5,631	\$6,006	\$5,461	\$6,450	\$7,781	\$8,759

Add Model Number as suffix - For Example: CUB V1616

NOTE: Dura-Coat Available at the same price as Veneer

COLECRAFT

Casegoods Public Spaces

Drum Tables

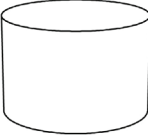
MODEL #	DIMENSIONS				
		LAMINATE W/O BASE (DR)	VENEER W/O BASE (DR)	DRBLAMINATE W/BASE (DRB)	DRB VENEER W/BASE (DRB)
L1716/V1716	17"D X 16"H	\$1,944	\$2,667	\$2,563	\$3,266
L1720/V1720	17"D X 20"H	\$2,031	\$2,775	\$2,654	\$3,388
L1724/V1724	17"D X 24"H	\$2,112	\$2,905	\$2,724	\$3,507
L1916/V1916	19"D X 16"H	\$2,112	\$2,905	\$2,750	\$3,528
L1920/V1920	19"D X 20"H	\$2,224	\$3,056	\$2,854	\$3,688
L1924/V1924	19"D X 24"H	\$2,295	\$3,149	\$2,933	\$3,794
L2116/V2116	21"D X 16"H	\$2,295	\$3,149	\$2,965	\$3,817
L2120/V2120	21"D X 20"H	\$2,433	\$3,337	\$3,107	\$3,996
L2124/V2124	21"D X 24"H	\$2,528	\$3,454	\$3,196	\$4,111
L2516/V2516	25"D X 16"H	\$2,528	\$3,454	\$3,216	\$4,136
L2520/V2520	25"D X 20"H	\$2,667	\$3,670	\$3,347	\$4,338
L2524/V2524	25"D X 24"H	\$2,775	\$3,817	\$3,468	\$4,489
L3116/V3116	31"D X 16"H	\$2,724	\$3,836	\$3,507	\$4,542
L3120/V3120	31"D X 20"H	\$2,933	\$4,017	\$3,647	\$4,719
L3716/V3716	37"D X 16"H	\$2,965	\$4,049	\$3,675	\$4,759
L3720/V3720	37"D X 20"H	\$3,115	\$4,258	\$3,826	\$5,091

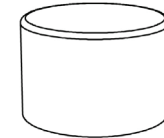
MODEL #	DIMENSIONS				
		LAMINATE W/O BASE (WBDR)	VENEER W/O BASE (WBDRB)	LAMINATE W/BASE (WBDRB)	VENEER W/BASE (WBDRB)
L1716/V1716	17"D X 16"H	\$3,181	\$3,515	\$3,551	\$3,887
L1720/V1720	17"D X 20"H	\$3,250	\$3,607	\$3,615	\$3,966
L1724/V1724	17"D X 24"H	\$3,294	\$3,681	\$3,666	\$4,038
L1916/V1916	19"D X 16"H	\$3,392	\$3,771	\$3,766	\$4,143
L1920/V1920	19"D X 20"H	\$3,464	\$3,887	\$3,843	\$4,268
L1924/V1924	19"D X 24"H	\$3,515	\$3,945	\$3,894	\$4,317
L2116/V2116	21"D X 16"H	\$3,607	\$4,038	\$3,985	\$4,415
L2120/V2120	21"D X 20"H	\$3,687	\$4,168	\$4,079	\$4,555
L2124/V2124	21"D X 24"H	\$3,766	\$4,258	\$4,153	\$4,655
L2516/V2516	25"D X 16"H	\$3,851	\$4,330	\$4,253	\$4,730
L2520/V2520	25"D X 20"H	\$3,953	\$4,472	\$4,357	\$4,864
L2524/V2524	25"D X 24"H	\$4,028	\$4,574	\$4,415	\$4,980
L3116/V3116	31"D X 16"H	\$4,128	\$4,689	\$4,540	\$5,091
L3120/V3120	31"D X 20"H	\$4,228	\$4,813	\$4,630	\$5,214
L3716/V3716	37"D X 16"H	\$4,330	\$4,925	\$4,730	\$5,427
L3720/V3720	37"D X 20"H	\$4,440	\$5,076	\$4,859	\$5,489

Add Model Number as suffix - For Example: WBDR V1716

NOTE: Dura-Coat Available at the same price as Veneer

**SQUARE CORNER PEDESTAL
(PED)**



MODEL #	DIMENSIONS	PRICE
L1030	10"W X 10"D X 30"H	\$1,036
V1030	10"W X 10"D X 30"H	\$1,608
L1230	12"W X 12"D X 30"H	\$1,102
V1230	12"W X 12"D X 30"H	\$1,688
L1236	12"W X 12"D X 36"H	\$1,191
V1236	12"W X 12"D X 36"H	\$1,884
L1630	16"W X 16"D X 30"H	\$1,516
V1630	16"W X 16"D X 30"H	\$2,273
L1636	16"W X 16"D X 36"H	\$1,689
V1636	16"W X 16"D X 36"H	\$2,614

**SOFTLINE RADIUS PEDESTAL
(SLPED)**

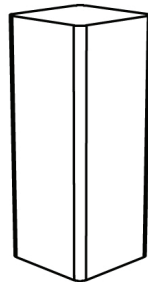

MODEL #	DIMENSIONS	PRICE
L1030	10"W X 10"D X 30"H	\$1,480
V1030	10"W X 10"D X 30"H	\$2,324
L1230	12"W X 12"D X 30"H	\$1,586
V1230	12"W X 12"D X 30"H	\$2,460
L1236	12"W X 12"D X 36"H	\$1,691
V1236	12"W X 12"D X 36"H	\$2,599
L1630	16"W X 16"D X 30"H	\$1,776
V1630	16"W X 16"D X 30"H	\$2,750
L1636	16"W X 16"D X 36"H	\$1,869
V1636	16"W X 16"D X 36"H	\$2,914

**WOOD BORDERED PEDESTAL
(WBPED)**

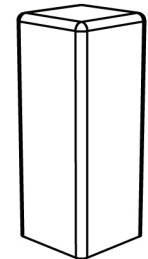

MODEL #	DIMENSIONS	PRICE
L1030	10"W X 10"D X 30"H	\$2,333
V1030	10"W X 10"D X 30"H	\$2,820
L1230	12"W X 12"D X 30"H	\$2,531
V1230	12"W X 12"D X 30"H	\$3,033
L1236	12"W X 12"D X 36"H	\$2,646
V1236	12"W X 12"D X 36"H	\$3,166
L1630	16"W X 16"D X 30"H	\$2,828
V1630	16"W X 16"D X 30"H	\$3,388
L1636	16"W X 16"D X 36"H	\$2,937
V1636	16"W X 16"D X 36"H	\$3,535

Add Model Number as suffix - For Example: PED L1030

NOTE: Dura-Coat Available at the same price as Veneer

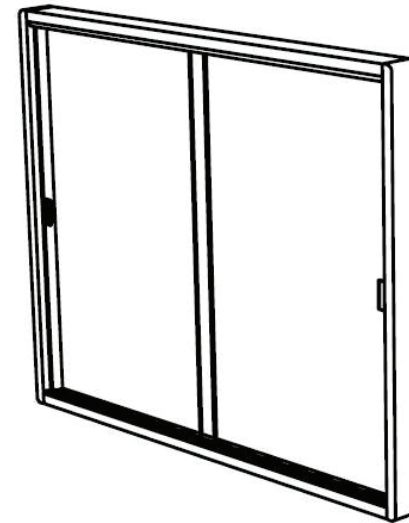

SLIDING DOOR WALL DISPLAY

- Hardwood Frame
- Fabric Tackboard
- Sliding Glass Doors with Lock
- Substitute Cork for \$100 List

MODEL #	DIMENSIONS	PRICE
DSC WH VN 48436	48"W X 4"D X 36"H	\$4,494
DSC WH VN 48448	48"W X 4"D X 48"H	\$5,052
DSC WH VN 60448	60"W X 4"D X 48"H	\$6,308

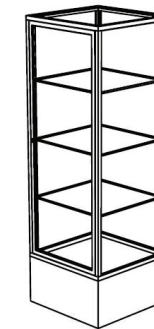

DISPLAY CASE

- Aluminum Frame
- Satin Anodized Finish
- Hinged Door with Lock
- Tempered Glass
- 3 Adjustable Glass Shelves
- Optional Light

MODEL #	DIMENSIONS	PRICE	PRICE with LIGHT
TRC GLS VN 181872	18"W X 18"D X 72"H	\$8,027	\$14,579
TRC GLS LM 181872	18"W X 18"D X 72"H	\$7,267	\$13,324
TRC GLS VN 242472	24"W X 24"D X 72"H	\$8,357	\$15,125
TRC GLS LM 242472	24"W X 24"D X 72"H	\$7,685	\$14,015

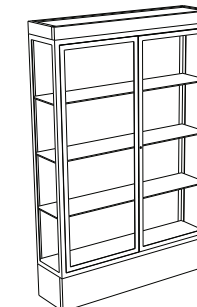

MODEL #	DIMENSIONS	PRICE	PRICE with LIGHT
DSPCS 481272	48"W X 12"D X 72"H	\$15,739	\$16,770
DSPCS 361272	36"W X 12"D X 72"H	\$14,004	\$15,035

TRADITIONAL LECTERNS

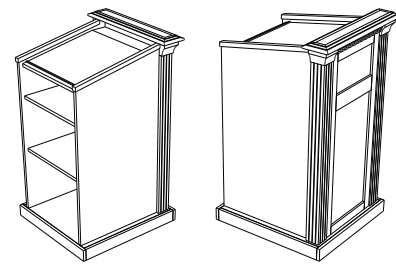

JAMESTOWN WOOD
JAMESTOWN WOOD

MODEL #	DIMENSIONS	PRICE
LEC JAM1 W	24"W X 23"D X 48"H	\$11,089
LEC JAM2 W	36"W X 23"D X 48"H	\$12,754

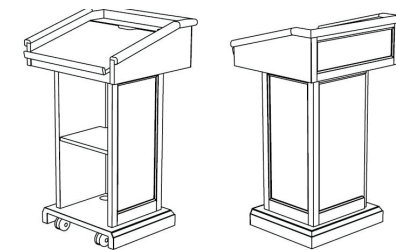

LEC TRAD VN 292749	29"W X 27"D X 49"H	\$10,082
LEC TRAD VN 362749	36"W X 27"D X 49"H	\$11,193

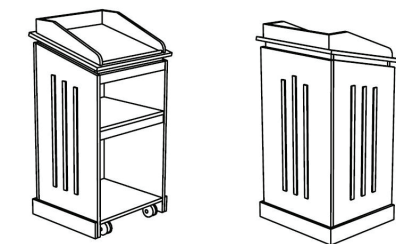

LEC TRAD VN 252348	25"W X 23"D X 48"H	\$8,288
LEC TRAD VN 362348	36"W X 23"D X 48"H	\$9,116

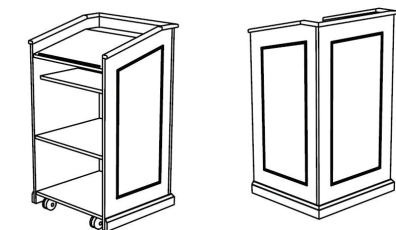

LEC TRAD VN 242548	24"W X 25"D X 48"H	\$6,271
LEC TRAD VN 362548	36"W X 25"D X 48"H	\$7,122

CLASSIC LECTERNS

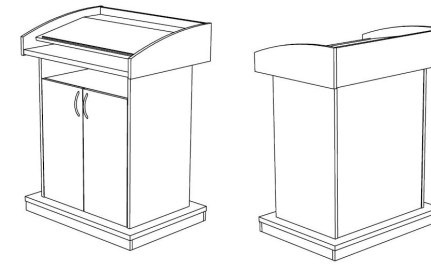

MODEL #	DIMENSIONS	PRICE
LEC CON VN 372748	37"W X 27"D X 48"H	\$7,551
LEC CON LM 372748	37"W X 27"D X 48"H	\$5,662
LEC CON VN 292748	29"W X 27"D X 48"H	\$6,795
LEC CON LM 292748	29"W X 27"D X 48"H	\$5,097

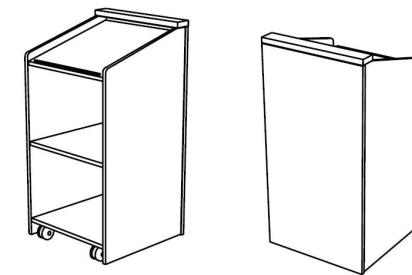

LEC CLA VN 2418	24"W X 18"D X 47"H	\$4,390
LEC CLA LM 2418	24"W X 18"D X 47"H	\$3,290
LEC CLA VN 2424	24"W X 24"D X 47"H	\$4,653
LEC CLA LM 2424	24"W X 24"D X 47"H	\$3,488
LEC CLA VN 3624	36"W X 24"D X 47"H	\$5,350
LEC CLA LM 3624	36"W X 24"D X 47"H	\$4,012

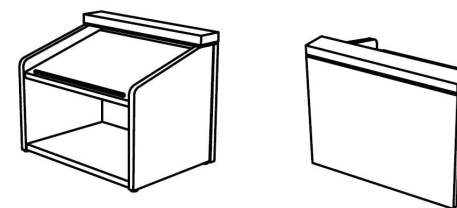

LEC TT VN 2115	21"W X 15"D X 17"H	\$1,832
LEC TT LM 2115	21"W X 15"D X 17"H	\$1,212

LECTERN LIGHT



MODEL #	PRICE
LEC LIGHT	\$555

Casegoods Adjustable Height Lecterns

ADJUSTABLE HEIGHT LECTERNS

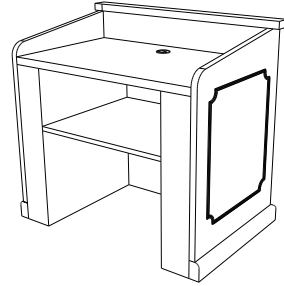
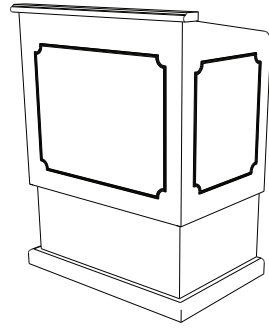
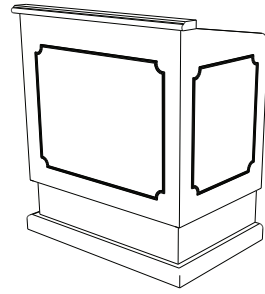
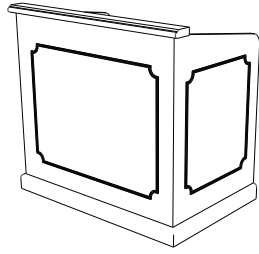

WILLIAMSBURG SHOWN

	MODEL #	DIMENSIONS	JAMESTOWN (VN)	WILLIAMSBURG (VN)	AHMHERST (VN)	AURORA (LM)
36" WIDE	LEC AH 362748__	36"W X 27"D X 36/48"H	\$19,294	\$15,305	\$13,294	\$10,545
48" WIDE	LEC AH 482748__	48"W X 27"D X 36/48"H	\$21,802	\$17,294	\$15,022	\$11,915
60" WIDE	LEC AH 602748__	60"W X 27"D X 36/48"H	\$24,636	\$19,542	\$16,975	\$13,464

COLECRAFT

Casegoods Lockers

COLECRAFT

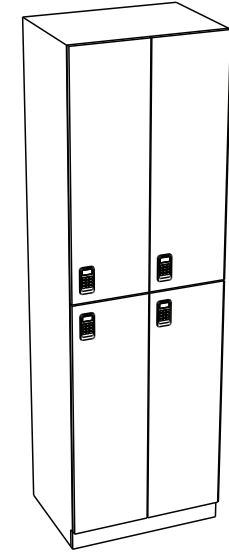

MODEL #	DIMENSIONS	LAMINATE (LM)	VENEER (VN)
LCKR_241878	24"W X 18"D X 78"H	\$6,763	\$7,565

LCKR_742472	72"W X 24"D X 72"H	\$19,836	\$25,424
-------------	--------------------	----------	----------

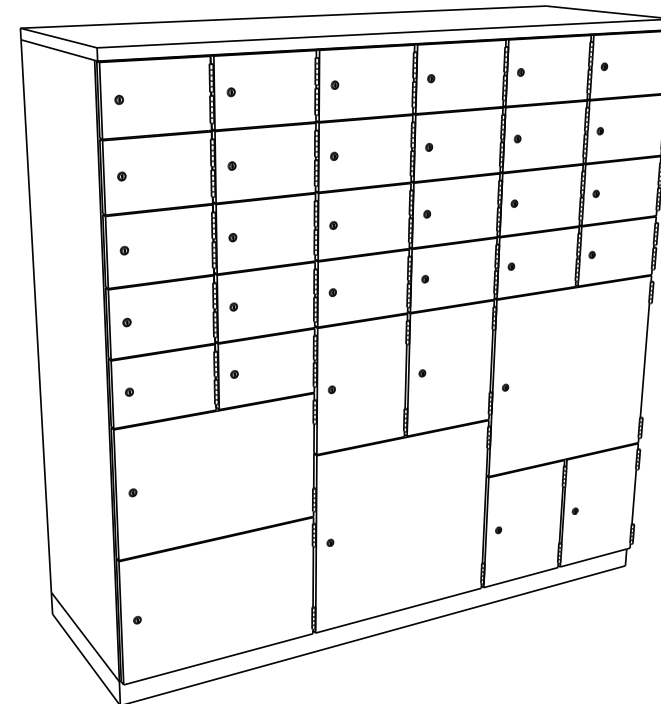

WHEN ORDERING USE MODEL NUMBER AND THE SPACE AFTER IS USED TO SIGNIFY STYLE. JAMESTOWN = JT • WILLIAMSBURGH = WB • AMHERST = AM • AURORA = AR

Tackboards

Ordering

1. Specify tackboard size
2. Specify surface material
Colecraft standard fabric options are available on page XX of the pricelist or on our website. COM and custom fabric is welcomed, contact customer service for more info.
3. Specify frame option / profile
Colecraft standard wood species and finish options are available in the Colors and Finishes section of the pricelist or on our website.

Example



1. Size	24" x 48" Tackboard	TBD4824
2. Material color	"Angora"	2335-2035
3. Frame	Vinyl Edge "Gray"	VE 3

FABRIC TACKBOARDS

MODEL #	DIMENSIONS	SELF EDGE	VINYL EDGE	ALUM FRAME	WOOD FRAME
TBD2418	18"w x 24"h	\$236	\$338	\$704	\$952
TBD3024	24"w x 30"h	\$364	\$465	\$767	\$994
TBD3624	24"w x 36"h	\$411	\$513	\$900	\$1,016
TBD4824	24"w x 48"h	\$439	\$612	\$938	\$1,164
TBD4832	32"w x 48"h	\$525	\$702	\$1,070	\$1,405
TBD3636	36"w x 36"h	\$461	\$600	\$995	\$1,204
TBD4836	36"w x 48"h	\$612	\$786	\$1,087	\$1,472
TBD3642	42"w x 36"h	\$525	\$702	\$1,035	\$1,405
TBD3648	48"w x 36"h	\$612	\$786	\$1,087	\$1,472
TBD4848	48"w x 48"h	\$754	\$905	\$1,249	\$1,708
TBD3660	60"w x 36"h	\$878	\$1,054	\$1,387	\$1,797
TBD4860	60"w x 48"h	\$947	\$1,098	\$1,413	\$1,821
TBD3672	72"w x 36"h	\$985	\$1,160	\$1,517	\$1,700
TBD4872	72"w x 48"h	\$1,087	\$1,237	\$1,649	\$2,124
TBD3684	84"w x 36"h	\$1,237	\$1,415	\$1,639	\$1,880
TBD4884	84"w x 48"h	\$1,295	\$1,446	\$1,785	\$2,350
TBD4896	96"w x 48"h	\$1,310	\$1,453	\$1,850	\$2,775

FOR FORBO TACK-BORDS ADD 25%

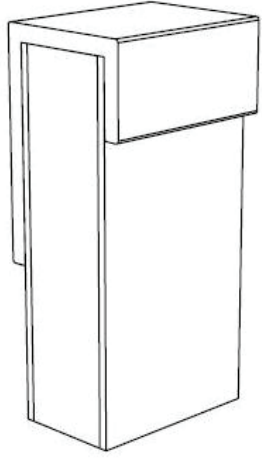
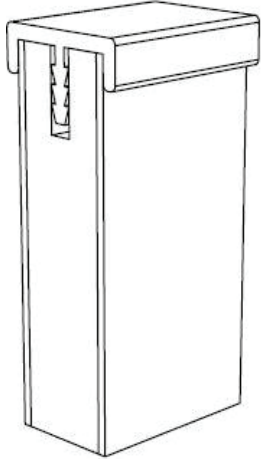
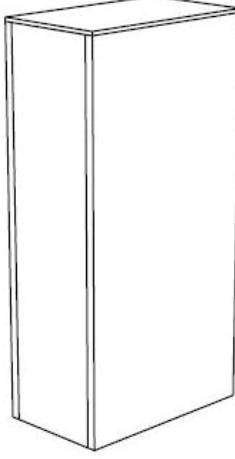
Frame Options

Wood Frame	Aluminum Frame	Vinyl Edge	Self Edge
Rectangular 			
Bevel 			
Radius 			
	Aluminum Frame Color Satin anodized finish	Vinyl Edge Colors 1 Brown • 2 Black • 3 Gray	Self Edge Colors Matches finish of tackboard material

Casegoods Visual Presentation

Whiteboards

COLECRAFT

Ordering

1. Specify whiteboard size
2. Specify surface material
3. Specify frame option / profile
 - Colecraft standard wood species and finish options are available in the Colors and Finishes section of the pricelist or on our website.
4. Specify accessories

Surface Options

PolyVision e3 Ceramicsteel

e3 Ceramicsteel is an ultra smooth, optically flat and highly durable ceramic-on-steel surface that delivers a lustrous and silky smooth writing experience. Dry marker pens glide across the surface with minimal friction, minimal marker wear and maximum coverage while maintaining all the benefits of a traditional ceramicsteel writing surface: magnetic, scratch resistant, abrasion resistant, chemical resistant and wear resistant.

Custom grid patterns and specific templates are available on Polyvision writing surfaces.



Wilsonart Marker Board Laminate

Wilsonart marker board laminate is a durable, gloss decorative surface that ensures easy erasure of dry erase markers. Marker board laminate is constructed from decorative surface papers that are pressed over kraft paper core sheets, then bonded, trimmed and the backs are sanded to facilitate bonding. This product is available in white, other colors are available.

All whiteboards include :
 Drywall mounting brackets and screws,
 1 set of markers,
 1 eraser
 1" - 14" wide marker rail

Frame Options

Wood Frame



Rectangular

Bevel



Radius



Aluminum Frame

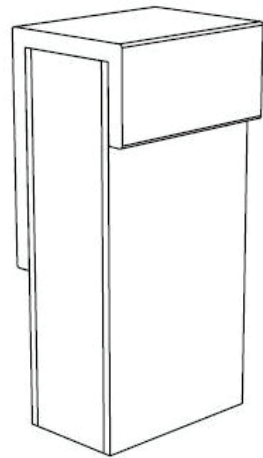

Aluminum Frame Color
Satin anodized finish

Vinyl Edge

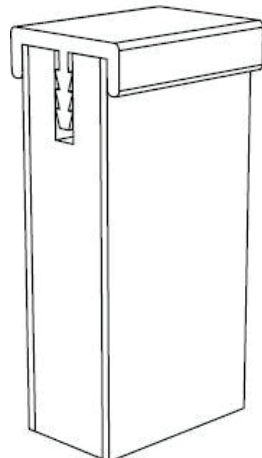

Vinyl Edge Colors
1 Brown • 2 Black • 3 Gray

Self Edge

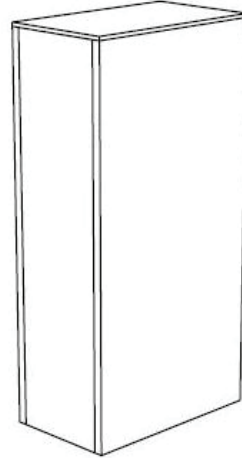

Self Edge Colors
Matches finish of tackboard material

Casegoods Visual Presentation

COLECRAFT

WHITEBOARDS POLYVISION E3 CERAMICSTEEL

MODEL #	DIMENSIONS	SELF EDGE	VINYL EDGE	ALUM FRAME	WOOD FRAME
WHBP3624	24"w x 36"h	N/A	\$619	\$1,098	\$1,198
WHBP4832	32"w x 48"h	N/A	\$815	\$1,446	\$1,576
WHBP2436	36"w x 24"h	N/A	\$619	\$1,098	\$1,198
WHBP3636	36"w x 36"h	N/A	\$775	\$1,417	\$1,498
WHBP4836	36"w x 48"h	N/A	\$845	\$1,500	\$1,635
WHBP3248	48"w x 32"h	N/A	\$815	\$1,446	\$1,576
WHBP3648	48"w x 36"h	N/A	\$845	\$1,500	\$1,635
WHBP4848	48"w x 48"h	N/A	\$989	\$1,745	\$1,911
WHBP4860	60"w x 48"h	N/A	\$1,198	\$2,046	\$2,322
WHBP4872	72"w x 48"h	N/A	\$1,405	\$2,348	\$2,718
WHBP4884	84"w x 48"h	N/A	\$1,589	\$2,579	\$3,077
WHBP4896	96"w x 48"h	N/A	\$1,764	\$2,863	\$3,415

WHITEBOARDS WILSONART LAMINATE

MODEL #	DIMENSIONS	SELF EDGE	VINYL EDGE	ALUM FRAME	WOOD FRAME
WHBL3624	24"w x 36"h	\$419	\$467	\$940	\$982
WHBL4832	32"w x 48"h	\$578	\$643	\$1,178	\$1,351
WHBL2436	36"w x 24"h	\$419	\$467	\$940	\$982
WHBL3636	36"w x 36"h	\$578	\$643	\$1,119	\$1,351
WHBL4836	36"w x 48"h	\$608	\$676	\$1,202	\$1,420
WHBL3248	48"w x 32"h	\$578	\$643	\$1,178	\$1,351
WHBL3648	48"w x 36"h	\$608	\$676	\$1,202	\$1,420
WHBL4848	48"w x 48"h	\$667	\$742	\$1,353	\$1,559
WHBL4860	60"w x 48"h	\$793	\$883	\$1,559	\$1,850
WHBL4872	72"w x 48"h	\$971	\$1,080	\$1,767	\$2,270
WHBL4884	84"w x 48"h	\$1,097	\$1,221	\$1,906	\$2,565
WHBL4896	96"w x 48"h	\$1,159	\$1,290	\$2,097	\$2,709

ACCESSORIES	PRICE
EXPO WHITE BOARD CLEANER - 8 OZ	\$28
4 DRY ERASE MARKING PENS	\$20
ERASER	\$11

Ordering

1. Specify presentation cabinet size
(Review open and closed dimensions)

2. Specify surface materials
Interior door surfaces can be specified as either fabric covered tackboard or additional writing surface. Colecraft standard fabric options are available in the Colors and Finishes section of the pricelist or on our website. COM and custom fabric is welcomed, contact customer service for more info.

3. Specify door profile
Colecraft standard wood species and finish options are available in the Colors and Finishes section of the pricelist or on our website.

Surface Options

PolyVision e3 Ceramicsteel

e3 Ceramicsteel is an ultra smooth, optically flat and highly durable ceramic-on-steel surface that delivers a lustrous and silky smooth writing experience. Dry marker pens glide across the surface with minimal friction, minimal marker wear and maximum coverage while maintaining all the benefits of a traditional ceramicsteel writing surface: magnetic, scratch resistant, abrasion resistant, chemical resistant and wear resistant.

Custom grid patterns and specific templates are available on Polyvision writing surfaces.



Wilsonart Marker Board Laminate

Wilsonart marker board laminate is a durable, gloss decorative surface that ensures easy erasure of dry erase markers. Marker board laminate is constructed from decorative surface papers that are pressed over kraft paper core sheets, then bonded, trimmed and the backs are sanded to facilitate bonding. This product is available in white, other colors are available.

All whiteboards include :
drywall mounting brackets and screws,
1 set of markers,
1 eraser
14" wide marker rail

Door Options

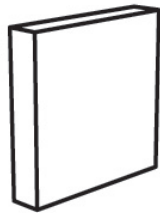

Rectilinear (REW)
(Wood or Laminate)

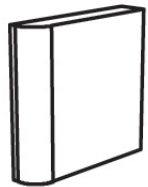

Vertical Radius (VRW)
(Wood)

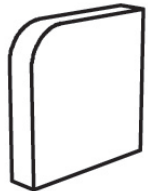

Curvilinear (CUW)
(Wood or Laminate)



Bullnose (BNW)
(Wood)

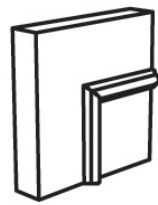

Traditional (TRW)
(Wood)

POLYVISION P3 CERAMICSTEEL	MODEL #	DIMENSIONS	RECT WOOD (REW)	VERTICAL RAD WOOD (VRW)	CURVILINEAR WOOD (CUW)	BULLNOSE WOOD (BNW)	TRADITIONAL WOOD (TRW)	RECT LAMI-NATE (REL)	CURV LAMI-NATE (CUL)
----------------------------	---------	------------	-----------------	-------------------------	------------------------	---------------------	------------------------	----------------------	----------------------

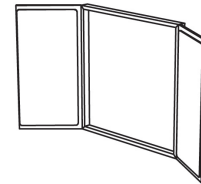

B030P	30"w x 42"h	\$3,094	\$3,236	\$3,637	\$4,032	\$4,495	\$2,255	\$3,109
B036P	36"w x 36"h	\$3,425	\$3,642	\$3,725	\$3,918	\$4,204	\$2,757	\$3,382
B032P	48"w x 32"h	\$3,671	\$3,971	\$4,154	\$4,762	\$5,312	\$2,969	\$3,781

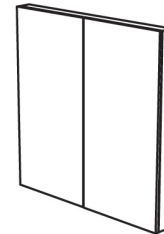

B048P	48"w x 48"h	\$4,646	\$4,950	\$4,866	\$5,255	\$5,912	\$3,540	\$4,384
B060P	60"w x 48"h	\$5,591	\$5,822	\$5,726	\$6,313	\$6,975	\$4,043	\$4,871
B072P	72"w x 48"h	\$6,550	\$7,631	\$6,682	\$6,933	\$7,716	\$5,718	\$6,646

WILSONART LAMINATE

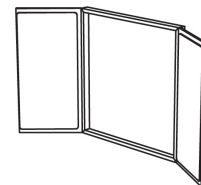

B030L	30"w x 42"h	\$2,645	\$3,049	\$3,137	\$3,498	\$3,919	\$1,882	\$2,659
B036L	36"w x 36"h	\$2,945	\$3,144	\$3,219	\$3,394	\$3,654	\$2,341	\$2,907
B032L	48"w x 32"h	\$3,170	\$3,444	\$3,607	\$4,160	\$4,660	\$2,530	\$3,269

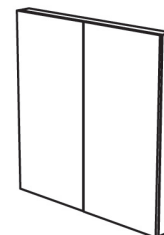

B048L	48"w x 48"h	\$3,971	\$4,247	\$4,171	\$4,526	\$5,123	\$2,966	\$3,734
B060L	60"w x 48"h	\$4,769	\$4,976	\$4,891	\$5,423	\$6,026	\$3,361	\$4,114
B072L	72"w x 48"h	\$5,577	\$5,929	\$5,697	\$5,926	\$6,637	\$4,349	\$5,114

Accessories
Flip Chart (pack of 4)

Models: B030, B032, B036, B048
\$67

Models: B060, B072
\$67

*Flip Chart is not available for 36"w x36"h cabinets.

Add door option to price - For Example: B060 CUW

COLECRAFT

Colecraft Commercial Furnishings

1021 Allen Street - Jamestown, NY 14701

Phone: (844)-500-9356 • (716) 488-2810

www.colecraftcf.com

Fax: (716) 488-2824

